

PREMIUM
DRAINAGE
SOLUTIONS

plato[®]
SHOWER DRAINER

Effortless Drainage
Refreshing experience

YOUR ULTIMATE GUIDE TO SEAMLESS
WATER MANAGEMENT

plato[®]
SHOWER DRAINER

REGENT BATHZ PVT. LTD.

Delhi (INDIA)

Email : info@platobath.com

www.platobath.com

Toll Free No. 1800 120 000 700



With a humble beginning 37 years ago, PLATO has come a long way & won the confidence of millions of Customers. PLATO presents the most lavish & contemporary bath fittings, accessories and essentials to beautify your own world, your home. The perfect fusion of timeless beauty, with comfortable working, to suit the changing lifestyles and distinctive architecture of modern decor.

With futuristic designs and innovative products, PLATO bath fittings & accessories, REGENT BATHZ PVT. LTD. is constantly providing & satisfying its valued customers with its quality products. We ensure that right from raw materials, to packaging, only the best materials are used for manufacturing of PLATO products.

Through continuous R & D, backed by experience of over 37 years, PLATO has evolved as a front-runner in the manufacturing and supplying of quality bath products & accessories. We have got an excellent production and R & D team. We believe that technology and innovation should not be confined only to premium brands and we ensure that each product should be Long Lasting. Equipped with latest facilities, know how technology PLATO has developed the latest designs of bath products, accessories & Drainage Systems.

It is being & will be our mission, to provide our customers with hassle free, quality products & Accessories for the years to come. Finally, we salute & express our Gratitude to all Distributors, Dealers, Stockist, Plumbers & above all the Consumers, for their continued patronage & constant support. We want to reassure all of them of our best services & products for the times to come.



Regent Bathz Pvt. Ltd.
CE Certificate



Regent Bathz Pvt. Ltd.
EMS Certificate



Regent Bathz Pvt. Ltd.
QMX Certificate

GERMAN
DESIGNS

EUROPEAN
Technology





Benefits of Channel Drains System

1. Can be fixed on Large Tiles / Slabs in bathrooms & Drain areas.
2. Improving water drainage to prevent water logging & keep the area dry.
3. Increasing the safety, reducing the risk of slips & falls.
4. Enhancing the value of the property & aesthetics.
5. Modern Channel Drains features sleek & minimalist designs that blend seamlessly with the surrounding landscape. Their low-profile appearance minimizes visual clutter & creates a clean & unobtrusive look, enhancing the overall aesthetic appeal of your property.
6. Channel drains come with a variety of grate options, including decorative grates, patterned grates, and grates made from different materials such as stainless steel, Glass, etc. These customizable options allow you to choose a grate design that complements the architectural style of your property, adding visual interest and personality to the space.
7. Channel drains contribute to a safer and more accessible environment for residents, visitors, and guests. Their presence ensures a dry and stable surface for walking, driving, and recreational activities, enhancing usability & enjoyment of outdoor spaces.
8. Drain systems offer a combination of functional performance and aesthetic appeal, allowing you to effectively manage surface water drainage while enhancing the visual appeal and value of your property.
9. Channel drains are designed to quickly and effectively drain water away from the surface.
10. This broader coverage ensures that water is collected and removed evenly.

Life Time Quality Assurance

Durability 25 years

Special Drainage Systems

plato we are a company with 40 years of Experience in the Water Technology. We understand that the **Quality, Design, Versatility & Durability** of the Stainless Steel Drainage Products, is the most important part of the selection process. The decisions are influenced by these factors. There are no industry standards as yet. We are setting the new standards.

plato Introduces the **Premium Quality** floor drainage systems. **Hygienic & Efficient Innovative & Outstanding** designs & Styles to enhance the aesthetics of you Bathrooms, Outdoors & Kitchens etc.

It is the result of European & Indian Designers Innovation.

Shower Channels in 304 High Grade Stainless Steel with 1.2mm thick Base & 1.5mm thick grates for smooth finish & extra long life.

First in India to provide specially designed **BRASS traps** that are very long lasting & **Deodorant (Odour free)** to keep your bathrooms pleasant.

Base Inlet / **Outlet 42-50MM** diameter (as per Model Design) for 50 lt/minute water Discharge.

Gasket Lock Technology for Zero Leakage.

Specially designed **BRASS** traps for long life & zero wear & tear.

Hair Catcher for easy cleaning & to stop Hair entering the trap.

ODOUR FREE & insect free mechanism in traps to keep your Bathroom pleasant.

High Grade SS 304 Stainless Steel with Nickle content 8% plus .

Most innovative, Elegant, Outstanding & functional designs to suit your taste & aesthetics.

Lengths :	300mm	: 450mm	: 600mm	: 750mm	: 900mm	: 1200mm
Widths :	60mm	: 80mm	: 100mm	: 125mm	: 140mm	: 150mm
				on Demand	on Demand	on Demand

Colours :

Available on Demand

SS Brushed	SS Silky Matt	Gold Brushed	Rose Gold Brushed
Gold Polished	Rose Gold Polished	Matt Black	

Top Grates : Solid Grates/ Perforated Grates / Heavy Wired Grates & Glass Lined Grates.

Domestic Drainage : Domestic Drainage Systems are used in Bathrooms, Kitchens, Lobby, Terrace balconies & roofs & Court yards. It is also used in Parking of Bungalows & Housing Societies. It is meant for Human Load only.

Outdoor Drainage : Outdoor Drainage Systems are used in Malls, Hotels, Hospitals, Parking lots, Swimming pools & Housing Societies etc. Where medium density human & other traffic like Bikes, Scooters & Cars are usually used.

Commercial Drainage : Commercial Drainage Systems are used in Food & Beverages, Wine, Beer, Milk & Petro Chemical industries. We can provide it in SS 304 & (SS 316 grades on demand).

FIRST TIME IN INDIA

Exclusive Traps for Different Sizes & Purposes :



BRITISH TECHNOLOGY

DRAINER COUPLER FIRST TIME IN INDIA



MAGLEV TECHNOLOGY

Magnetic Levitation Technology has created a unique drain core.

HIGH WATER FLOW RATE

Due to the large grille & Whirlpool Technology the water flow speed is quite high. It can drain without ponding over when multiple showers are working.

TORNADO SELF-CLEANING TECHNOLOGY

It has created an original Rotary Bonnet Drainage Technology which throws away sand, soap other small dirt.

NO OVERFLOW

Rainstorms like sanitary problems may result in water overflow. It has been created to block water backflow.

MAGNET ISOLATION

Egg-Shaped drain core contains and isolates the working magnets from the surrounding environment. The Egg-Shape design ensures that no dirt will be accumulate on the core.

NEOPRIU INVENTION IN ODOURLESS TECHNOLOGY









This state-of-the-Art Development in stopping cockroaches, insects & Foul Odour marks this trap a real wonder, the membrane opens only with the flow of water & closes itself after the water has been drained out.



INDEX





Exclusivo Series  **01-02**

3" Drainers with Pipe Outlet **03-22**



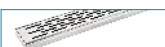



- SOLID TILE INSERT 
- GLASS LINED DRAINER 
- ZINGA SERIES 
- WAVE SERIES 
- GALAXY SERIES 
- BOXE SERIES 
- GIRARE SERIES 
- VARSACE SERIES 
- MAZEX SERIES 
- DEXTON **STRONG** 

Concealed Wall Drainer **23-24**

3" Drainers **25-34**

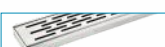
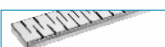
- TRINITY SERIES 
- LINEX SERIES 
- BOXE SERIES 
- GALAXY SERIES 
- GIRARE SERIES 

4" Drainers **35-48**

- SOLID TILE INSERT 
- GLASS LINED SURFACE 
- LINEX SERIES 
- CRUZE SERIES 
- BOXE SERIES 
- TRINITY SERIES 
- GIRARE SERIES 

2" Drainers **49-52**

- LINEX **SLEEK** 
- TRINITY **SLEEK** 

Scupper / Roof Drain **53-54**

SS Square Floor Drainer / SS Corner Drainer **55-56**

Premium Brass Forged **57-59**

LANZO / SALWEEN / KWANDO

Balcony Drainers **60**

Outlet Attachments **60**

Commercial Drainers **61-70**

JUMBO / JUMBO CORNER / JUMBO MANHOLE COVER
 DEXTON / DEXTON CORNER / DEXTON MANHOLE COVER
 LINZO / LINZO CORNER / SLOT DRAIN

GT Cover Spl. **71-72**





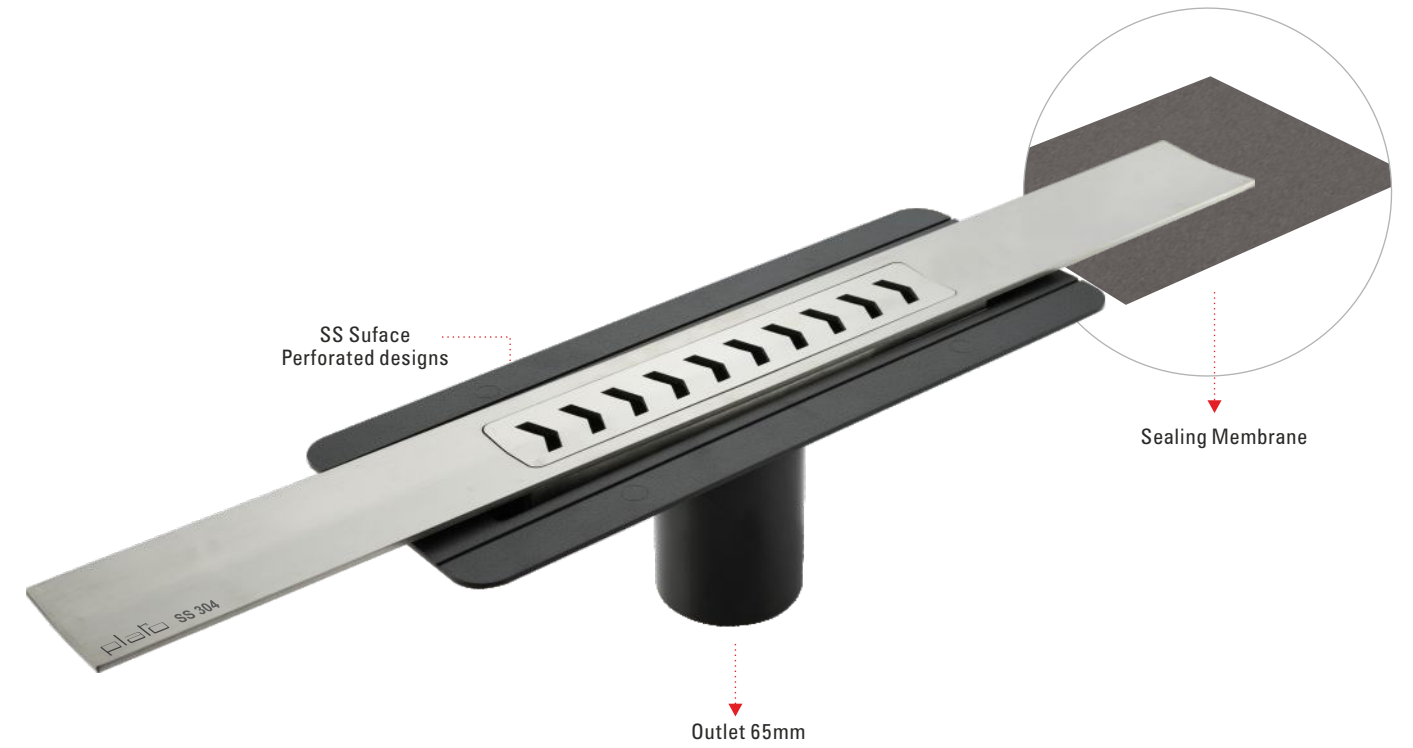

Liquid Soap Dispenser / Grab Bar Brass / Shower Seat **73-75**

SS Gratings & Cockroach Traps / Pop-up Trap & Tile Gratings **76-77**

HDPE Channel Drains **78**



SPECIFICATION

-  Installation depth
120 mm
-  Grate thickness
3 mm
-  Drainage capacity
50 Ltr/min
-  Outlet
65 mm
-  Anti Cockroach
No Foul Smell
-  Hair Catcher
-  **NO LEAK** Anti Leak

EXCLUSIVO DRAINER

Cat No.	Size	M.R.P (₹)
75P9003	24" (75 x 600mm)	10400/-
75P9004	36" (75 x 900mm)	13500/-

*Other sizes can also be Customized on Bulk Orders.



★ Life Time Quality Assurance







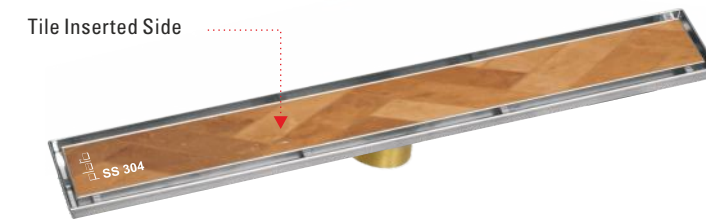
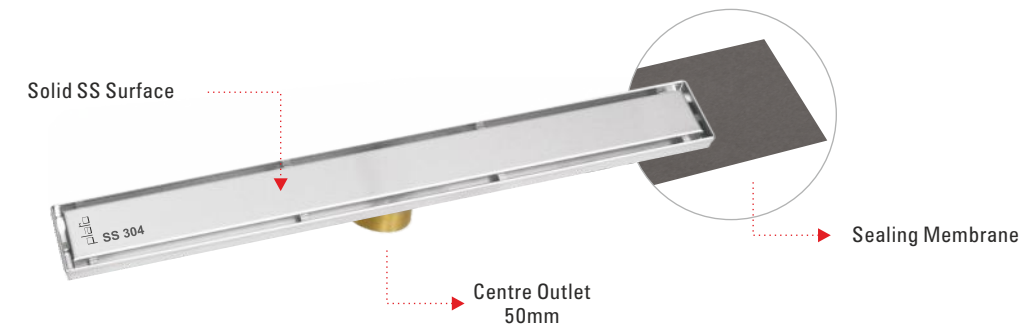

SOLID TILE DRAINER
WITH CENTRE OUTLET

GERMAN TECHNOLOGY

Made of
SS 304



-  Installation depth **90mm/ with Trap 110 mm**
-  Tile inlay depth **15mm**
-  Drainage capacity **40 Ltr/min** Outlet **50 mm**
-  Anti Cockroach
No Foul Smell
-  Hair Catcher
-  Anti Leak

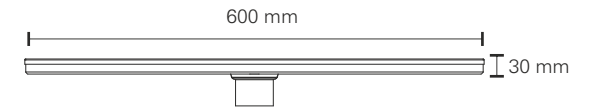

SOLID TILE DRAINER
WITH SIDE OUTLET



Cat No.	Size	Matt M.R.P (₹)	PVD M.R.P (₹)
75P7501 CH	24" (75 x 600mm)	6750/-	9300/-
75P7502 CH	12" (75 x 300mm)	4500/-	6300/-
75P7503 CH	18" (75 x 450mm)	5400/-	7500/-
75P7504 CH	30" (75 x 750mm)	7500/-	10800/-
75P7505 CH	36" (75 x 900mm)	8700/-	12600/-
75P7501 SH	24" (75 x 600mm)	6750/-	9300/-
75P7502 SH	12" (75 x 300mm)	4500/-	6300/-
75P7503 SH	18" (75 x 450mm)	5400/-	7500/-
75P7504 SH	30" (75 x 750mm)	7500/-	10800/-
75P7505 SH	36" (75 x 900mm)	8700/-	12600/-

*Other sizes can also be Customized on Bulk Orders.

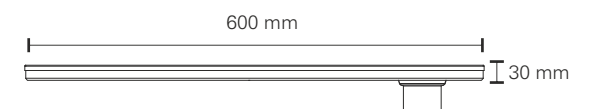

★ Life Time Quality Assurance

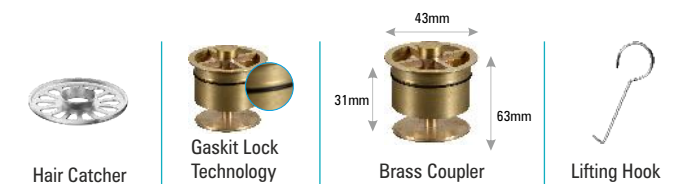







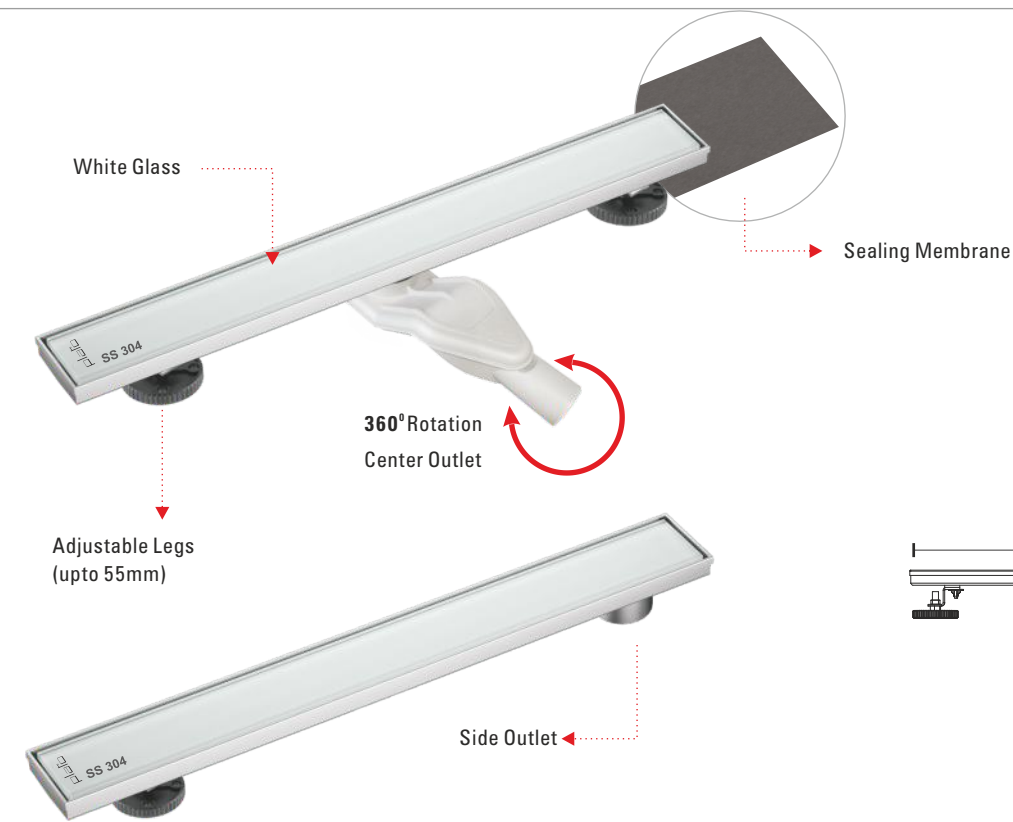

GLASS LINED DRAINER
WITH CENTRE / SIDE OUTLET

GERMAN TECHNOLOGY

Made of
SS 304



-  Installation depth **90mm/ with Trap 110 mm**
-  Glass Thickness **12mm**
-  Drainage capacity **Outlet 40 Ltr/min 50 mm**
-  Anti Cockroach
No Foul Smell
-  Hair Catcher
-  **NO LEAK** Anti Leak

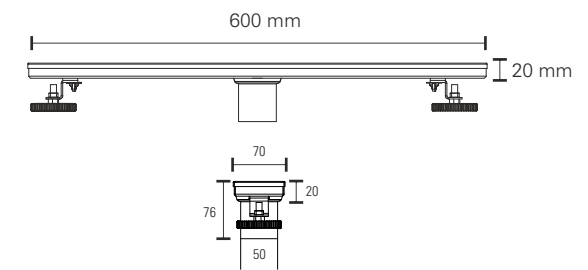

Cat No.	Size	Colour	M.R.P (₹)
75P7510 CH	24" (75 x 600mm)	White	7200/-
75P7510 SH	24" (75 x 600mm)	White	7200/-

*Other sizes can also be Customized on Bulk Orders.

BLACK GLASS LINED DRAINER
WITH CENTRE / SIDE OUTLET

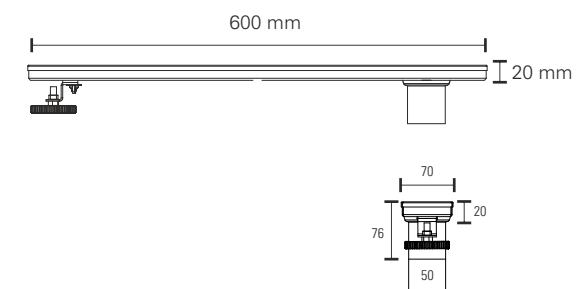

Cat No.	Size	Colour	M.R.P (₹)
75P7520 CH	24" (75 x 600mm)	Black	7200/-
75P7520 SH	24" (75 x 600mm)	Black	7200/-

*Other sizes can also be Customized on Bulk Orders.

★ Life Time Quality Assurance





SHOWER DRAINER
WITH CENTRE OUTLET

GERMAN TECHNOLOGY

Made of
SS 304

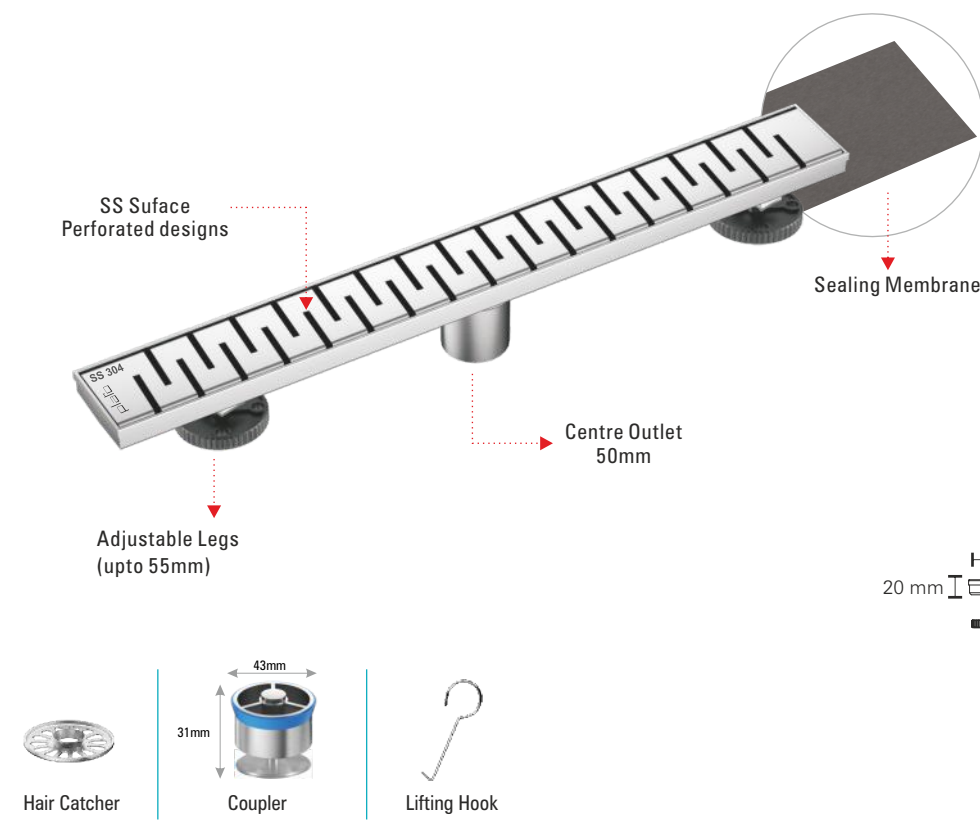

- Installation depth **90mm/ with Trap 110 mm**
- Grate depth **20mm**
- Drainage capacity **Outlet 40 Ltr/min 50 mm**
- Anti Cockroach
No Foul Smell
- Hair Catcher
- Anti Leak

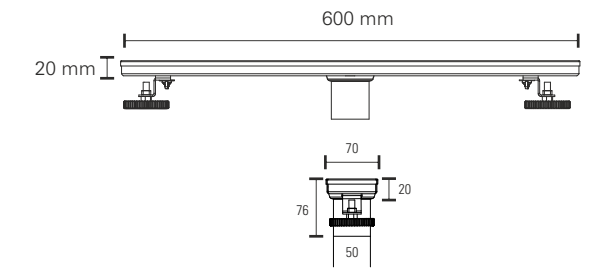

CENTRE OUTLET

Cat No.	Size	M.R.P (₹)
75P7530 CH	24" (75 x 600mm)	6750/-

*Other sizes can also be Customized on Bulk Orders.

SHOWER DRAINER
WITH SIDE OUTLET

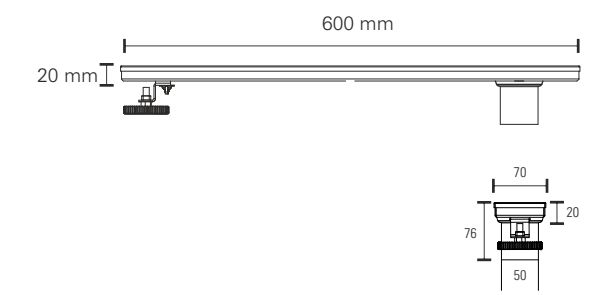
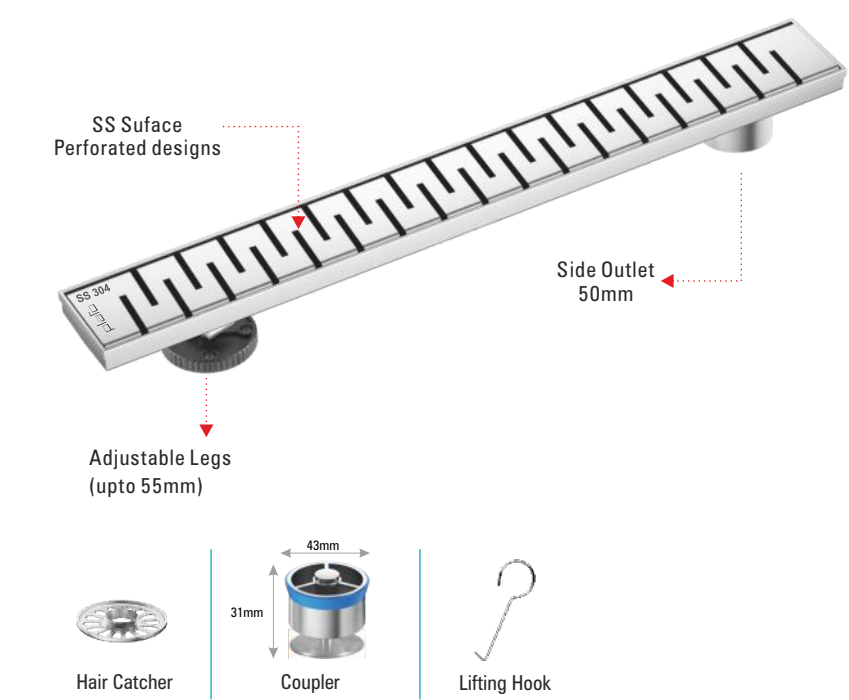

SIDE OUTLET

Cat No.	Size	M.R.P (₹)
75P7530 SH	24" (75 x 600mm)	6750/-

*Other sizes can also be Customized on Bulk Orders.

★ Life Time Quality Assurance



SHOWER DRAINER
WITH CENTRE OUTLET

GERMAN TECHNOLOGY

Made of
SS 304

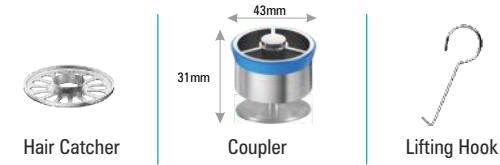
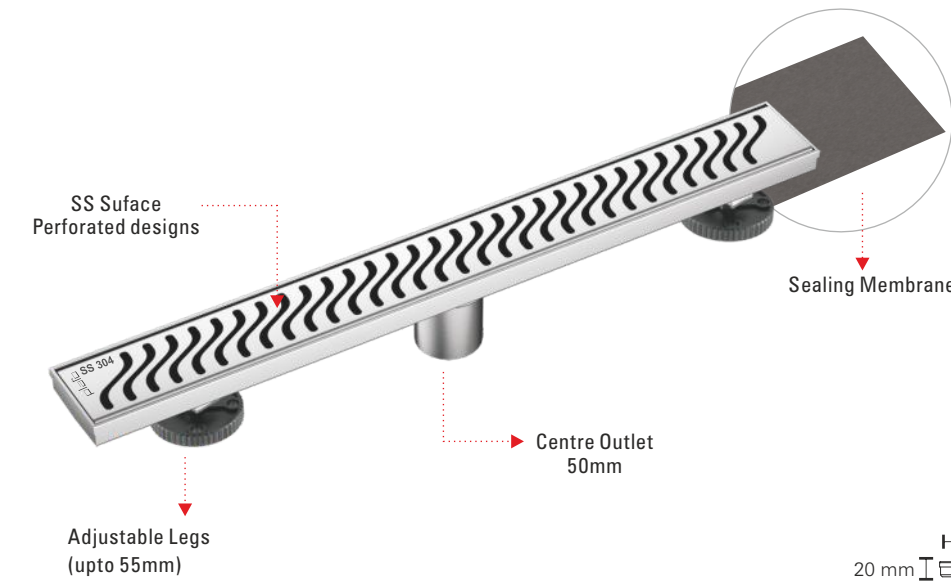

- Installation depth **90mm/ with Trap 110 mm**
- Grate depth **20mm**
- Drainage capacity **Outlet 40 Ltr/min 50 mm**
- Anti Cockroach No Foul Smell**
- Hair Catcher**
- Anti Leak**

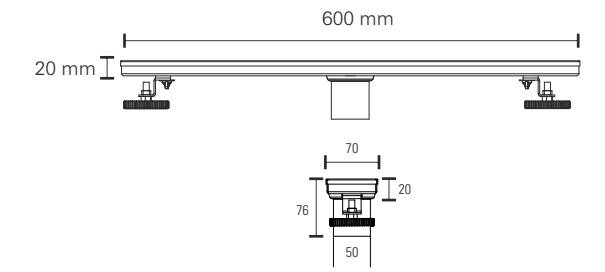

CENTRE OUTLET

Cat No.	Size	M.R.P (₹)
75P7540 CH	24" (75 x 600mm)	6750/-

*Other sizes can also be Customized on Bulk Orders.

SHOWER DRAINER
WITH SIDE OUTLET

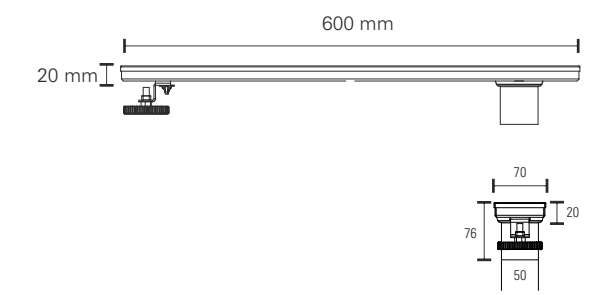
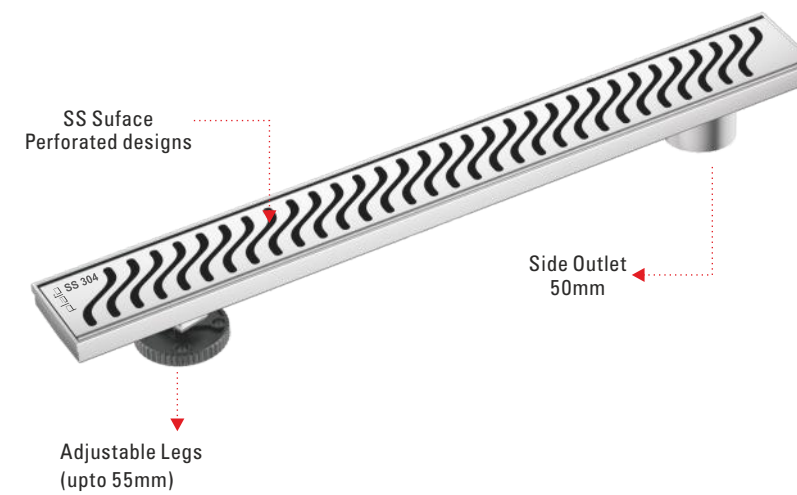

SIDE OUTLET

Cat No.	Size	M.R.P (₹)
75P7540 SH	24" (75 x 600mm)	6750/-

*Other sizes can also be Customized on Bulk Orders.

★ Life Time Quality Assurance



**SHOWER DRAINER
WITH CENTRE OUTLET**

GERMAN TECHNOLOGY

Made of
SS 304

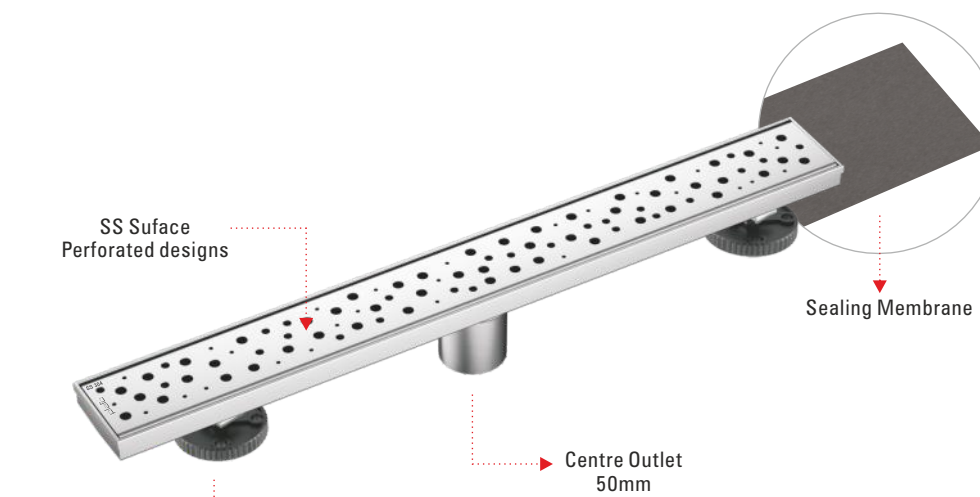

- Installation depth **90mm/ with Trap 110 mm**
- Grate depth **20mm**
- Drainage capacity **40 Ltr/min** Outlet **50 mm**
- Anti Cockroach
No Foul Smell
- Hair Catcher
- Anti Leak

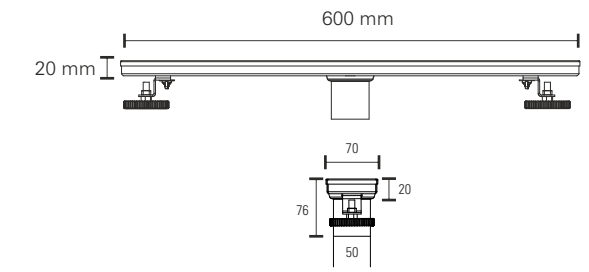
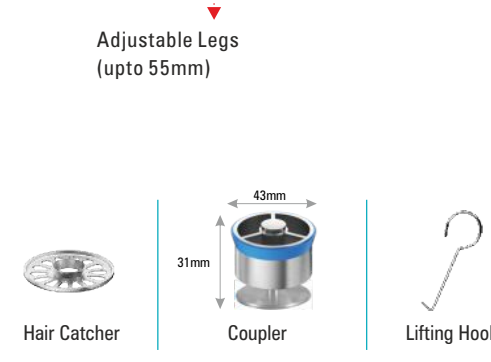

CENTRE OUTLET

Cat No.	Size	M.R.P (₹)
75P7550 CH	24" (75 x 600mm)	6750/-

*Other sizes can also be Customized on Bulk Orders.

**SHOWER DRAINER
WITH SIDE OUTLET**

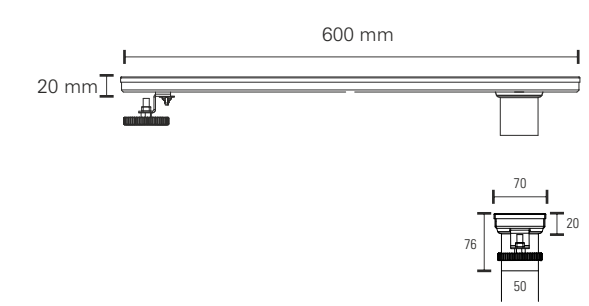
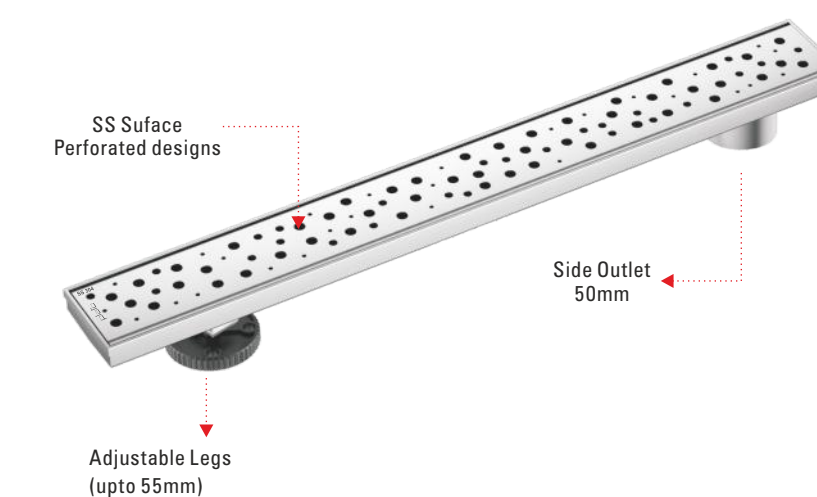

SIDE OUTLET

Cat No.	Size	M.R.P (₹)
75P7550 SH	24" (75 x 600mm)	6750/-

*Other sizes can also be Customized on Bulk Orders.

★ Life Time Quality Assurance



**SHOWER DRAINER
WITH CENTRE OUTLET**

GERMAN TECHNOLOGY

Made of
SS 304

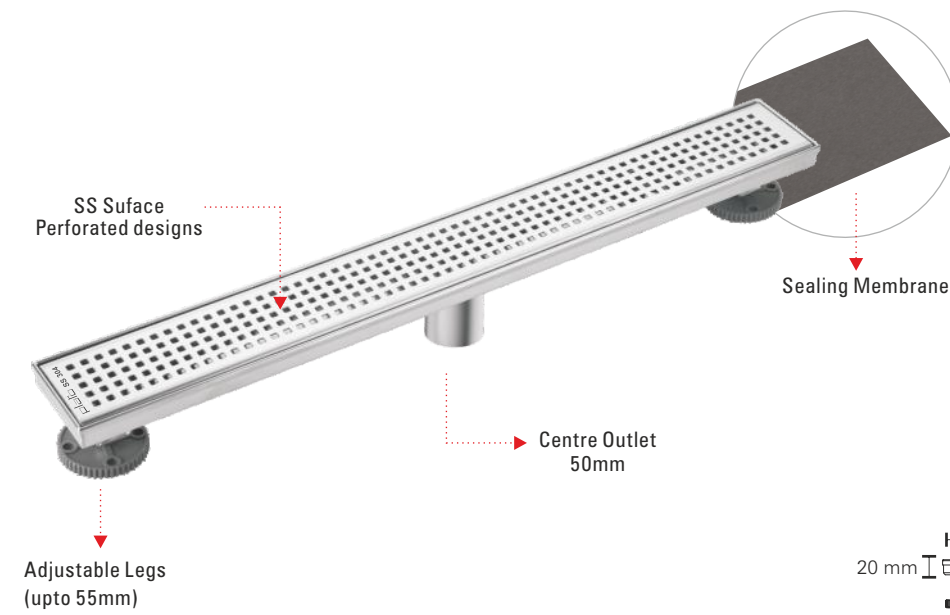

- Installation depth **90mm/ with Trap 110 mm**
- Grate depth **20mm**
- Drainage capacity **40 Ltr/min** Outlet **50 mm**
- Anti Cockroach
No Foul Smell
- Hair Catcher
- Anti Leak

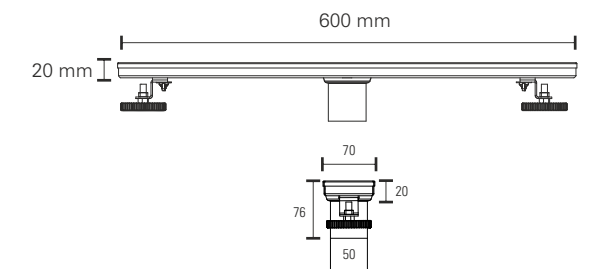

CENTRE OUTLET

Cat No.	Size	M.R.P (₹)
75P7560 CH	24" (75 x 600mm)	6750/-

*Other sizes can also be Customized on Bulk Orders.

**SHOWER DRAINER
WITH SIDE OUTLET**

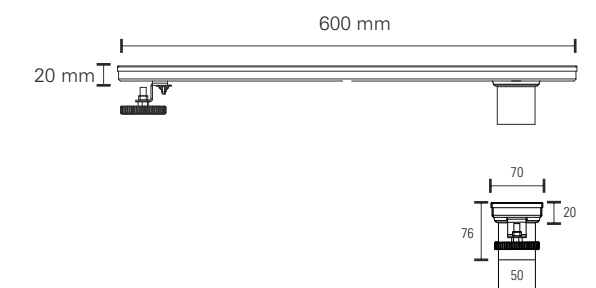
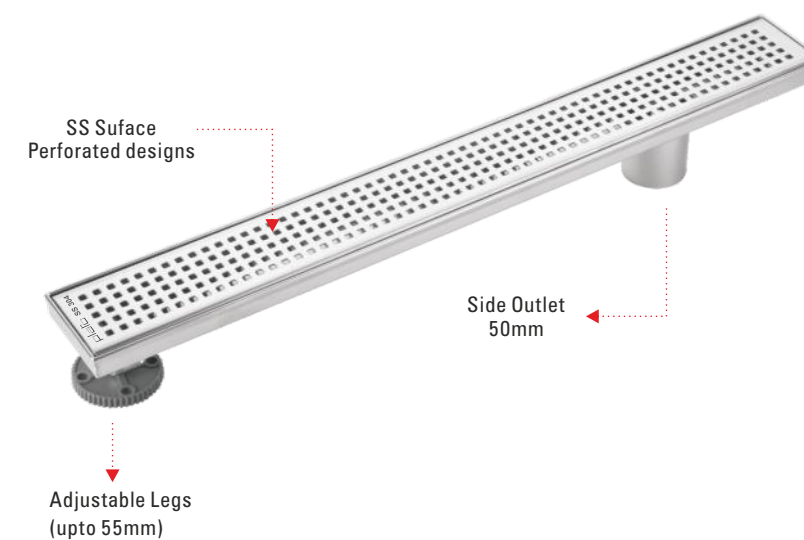

SIDE OUTLET

Cat No.	Size	M.R.P (₹)
75P7560 SH	24" (75 x 600mm)	6750/-

*Other sizes can also be Customized on Bulk Orders.

★ Life Time Quality Assurance







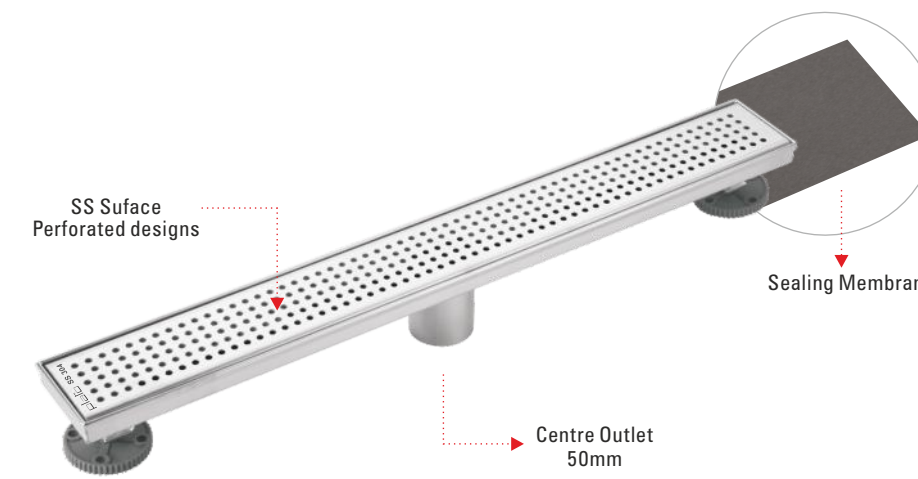

SHOWER DRAINER
WITH CENTRE OUTLET

GERMAN TECHNOLOGY

Made of
SS 304



-  Installation depth
90mm/ with Trap 110 mm
-  Grate depth
20mm
-  Drainage capacity **40 Ltr/min** Outlet **50 mm**
-  Anti Cockroach
No Foul Smell
-  Hair Catcher
-  Anti Leak

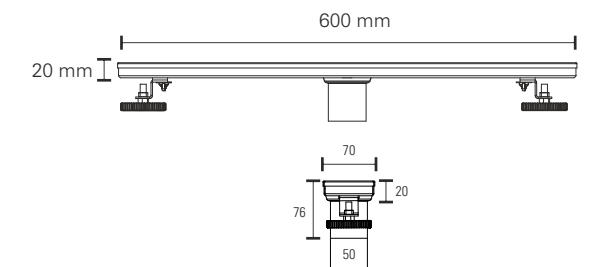

CENTRE OUTLET

Cat No.	Size	M.R.P (₹)
75P7570 CH	24" (75 x 600mm)	6750/-

*Other sizes can also be Customized on Bulk Orders.

SHOWER DRAINER
WITH SIDE OUTLET

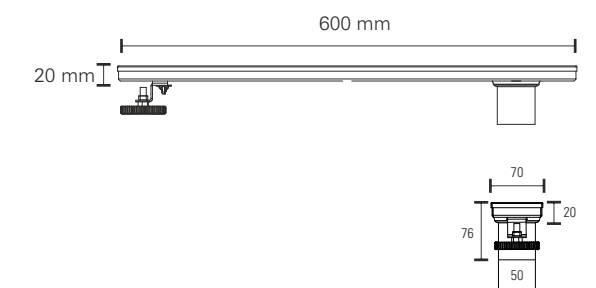
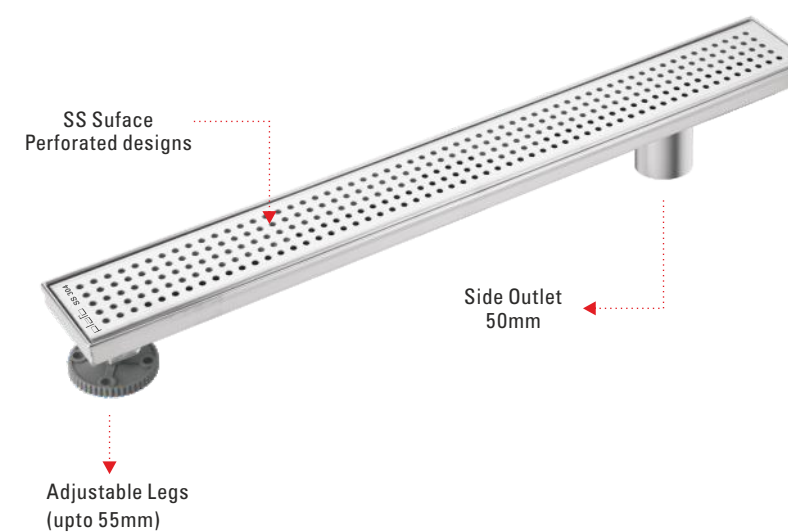

SIDE OUTLET

Cat No.	Size	M.R.P (₹)
75P7570 SH	24" (75 x 600mm)	6750/-

*Other sizes can also be Customized on Bulk Orders.

★ Life Time Quality Assurance







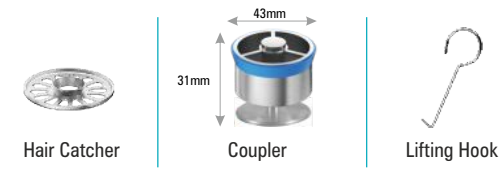
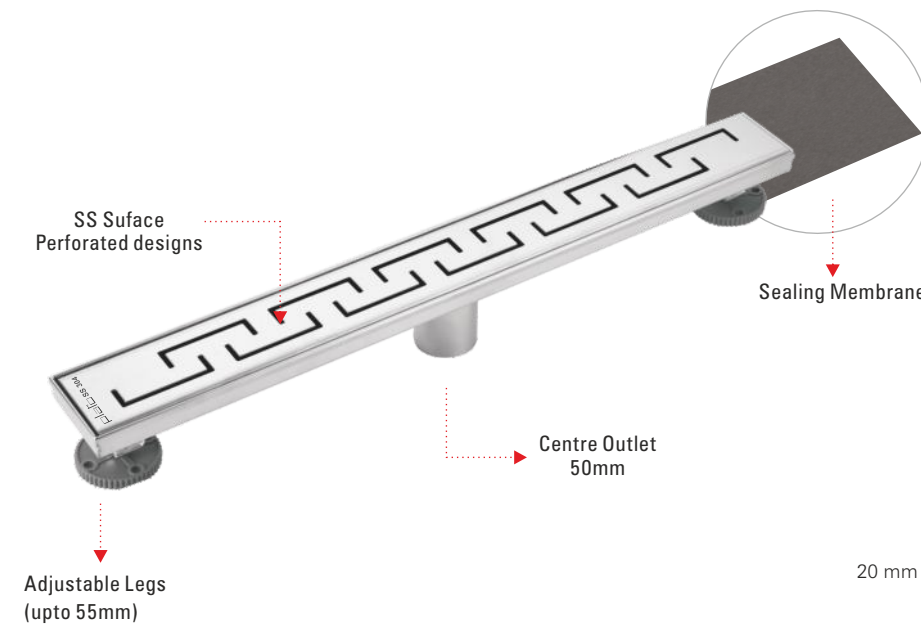

**SHOWER DRAINER
WITH CENTRE OUTLET**

GERMAN TECHNOLOGY

Made of
SS 304



-  Installation depth **90mm/ with Trap 110 mm**
-  Grate depth **20mm**
-  Drainage capacity **40 Ltr/min** Outlet **50 mm**
-  Anti Cockroach
No Foul Smell
-  Hair Catcher
-  **NO LEAK** Anti Leak

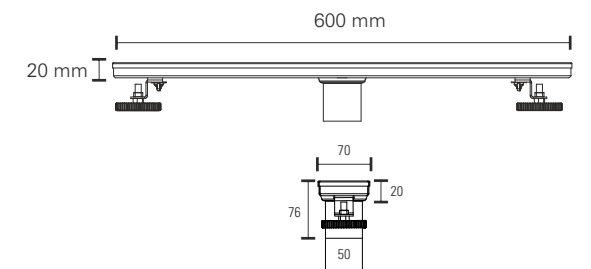

CENTRE OUTLET

Cat No.	Size	M.R.P (₹)
75P7580 CH	24" (75 x 600mm)	6750/-

*Other sizes can also be Customized on Bulk Orders.

**SHOWER DRAINER
WITH SIDE OUTLET**

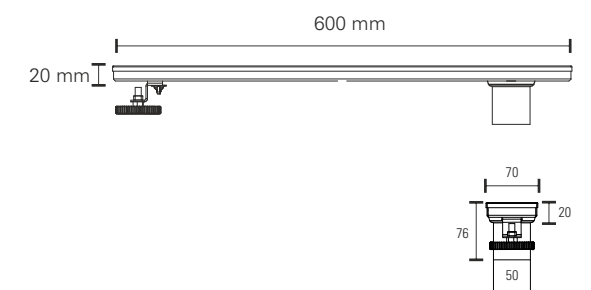
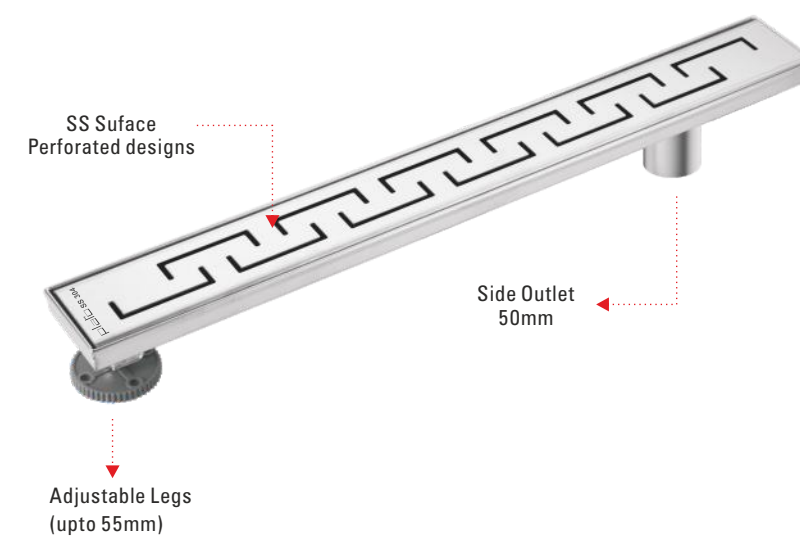

SIDE OUTLET

Cat No.	Size	M.R.P (₹)
75P7580 SH	24" (75 x 600mm)	6750/-

*Other sizes can also be Customized on Bulk Orders.

★ Life Time Quality Assurance







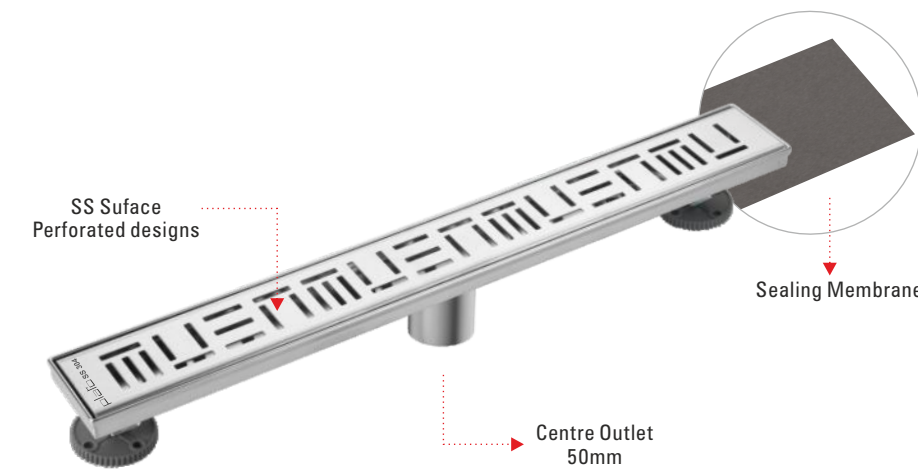

SHOWER DRAINER
WITH CENTRE OUTLET

GERMAN TECHNOLOGY

Made of
SS 304



-  Installation depth
90mm/ with Trap 110 mm
-  Grate depth
20mm
-  Drainage capacity
40 Ltr/min Outlet
50 mm
-  Anti Cockroach
No Foul Smell
-  Hair Catcher
-  Anti Leak

Adjustable Legs
(upto 55mm)

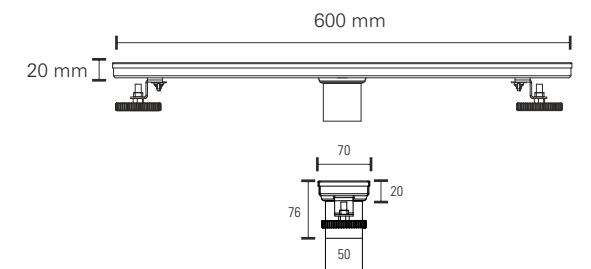

CENTRE OUTLET

Cat No.	Size	M.R.P (₹)
75P7590 CH	24" (75 x 600mm)	6750/-

*Other sizes can also be Customized on Bulk Orders.

SHOWER DRAINER
WITH SIDE OUTLET

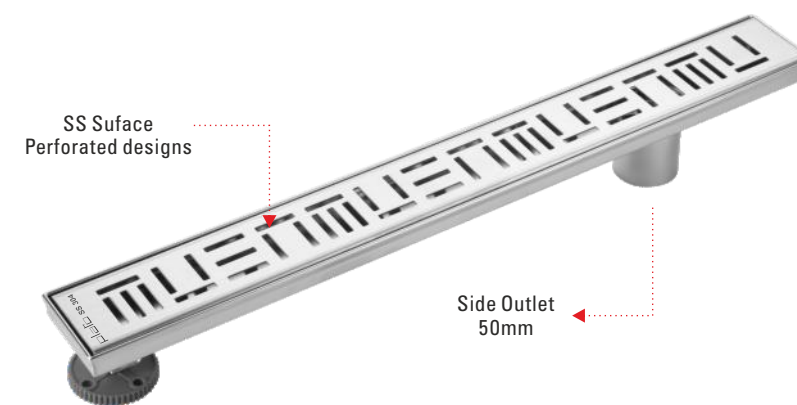

Adjustable Legs
(upto 55mm)

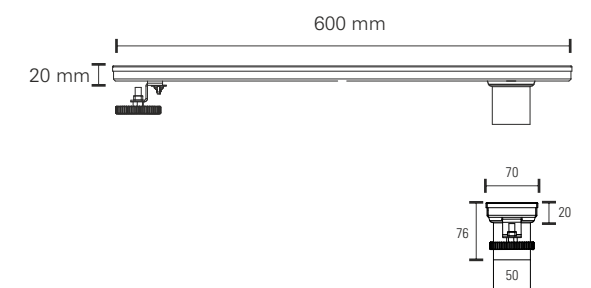

SIDE OUTLET

Cat No.	Size	M.R.P (₹)
75P7590 SH	24" (75 x 600mm)	6750/-

*Other sizes can also be Customized on Bulk Orders.

★ Life Time Quality Assurance

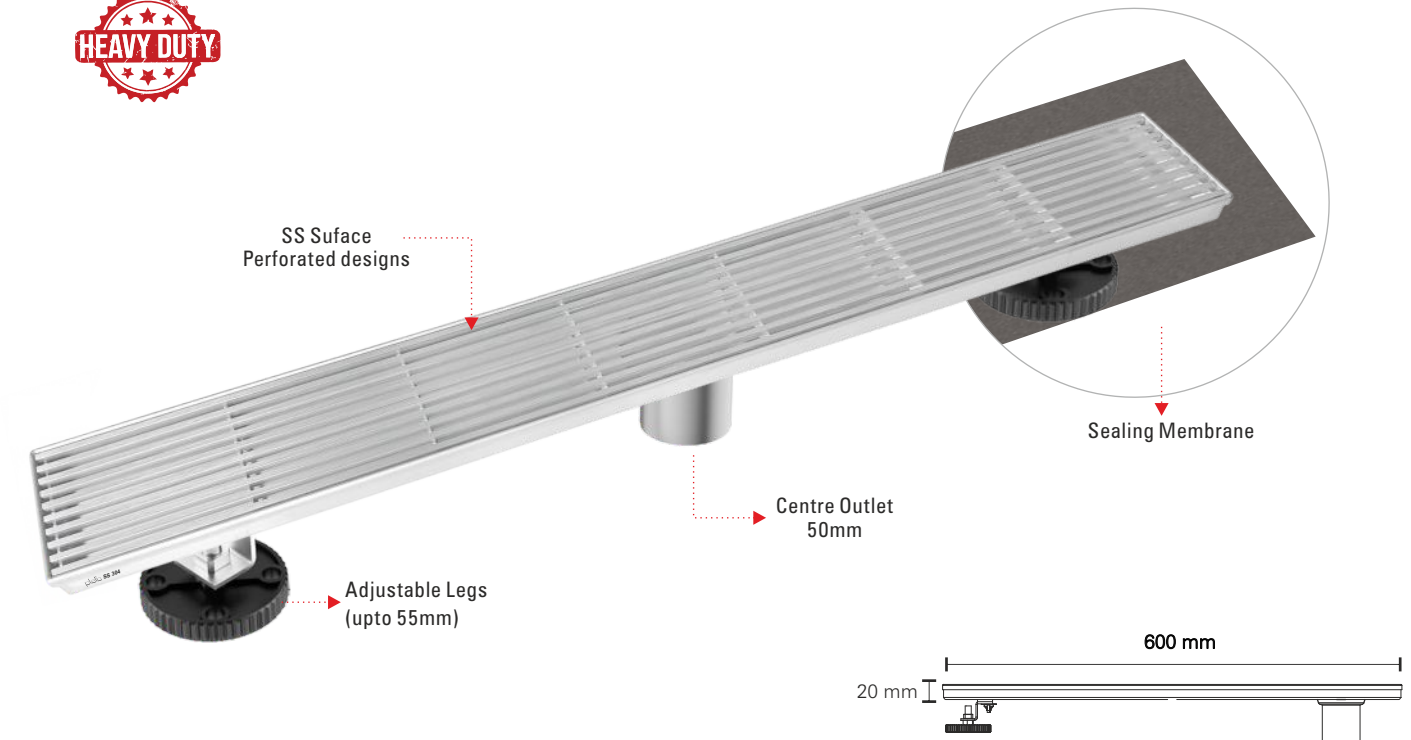

SPECIFICATION

- Installation depth
90 mm/ with Trap 110mm
- Grate depth
20 mm
- Drainage capacity
40 Ltr/min
- Outlet
50 mm
- Anti Cockroach
No Foul Smell
- Hair Catcher
- NO LEAK Anti Leak

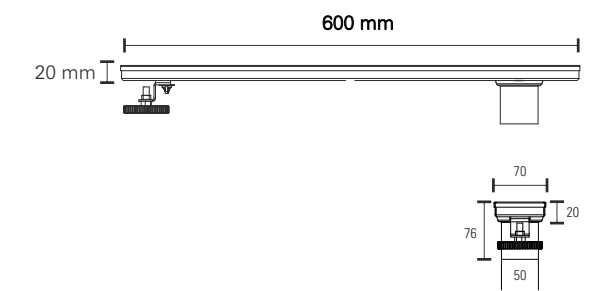
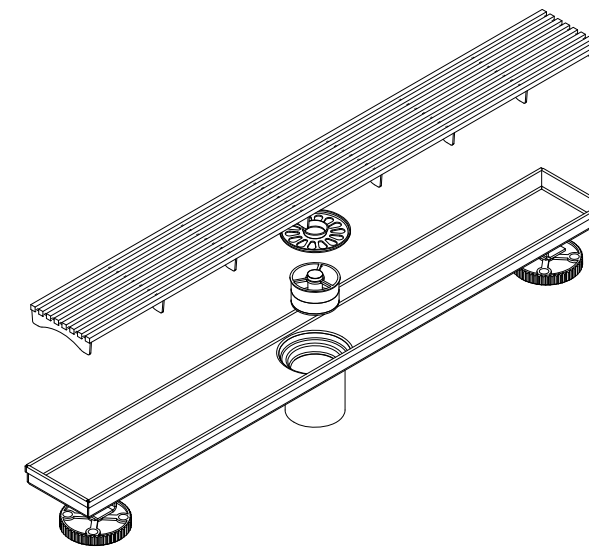

DEXTON DRAINER

Cat No.	Size	M.R.P (₹)
75P7600 CH	24" (75 x 600mm)	7500/-

*Other sizes can also be Customized on Bulk Orders.



Outlet Attachment

Cat. No : ALD-PO5040 for 50mm Drainer Outlet
M.R.P. : ₹ 1050/-

★ Life Time Quality Assurance

CONCEALED WALL DRAINER



CONCEALED WALL DRAINER WITH CENTRE OUTLET

GERMAN TECHNOLOGY

Made of
SS 304

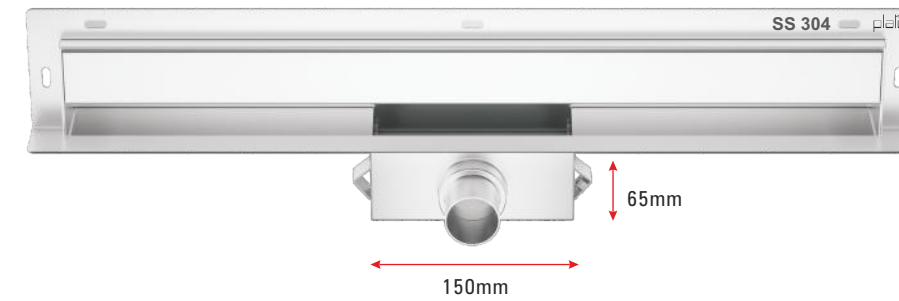

- Installation depth
90 / 120 mm
 - Drainage capacity
50 Ltr/min
 - Anti Cockroach
No Foul Smell
 - Hair Catcher
 - Anti Leak
- Outlet
40 mm



Extension Pipe
Cat. No : ALD-EXPWD

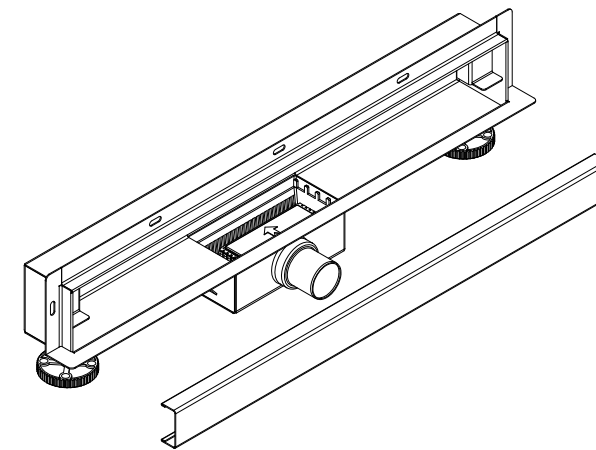
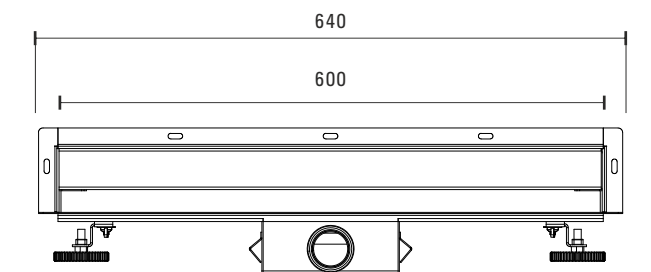

CENTRE OUTLET





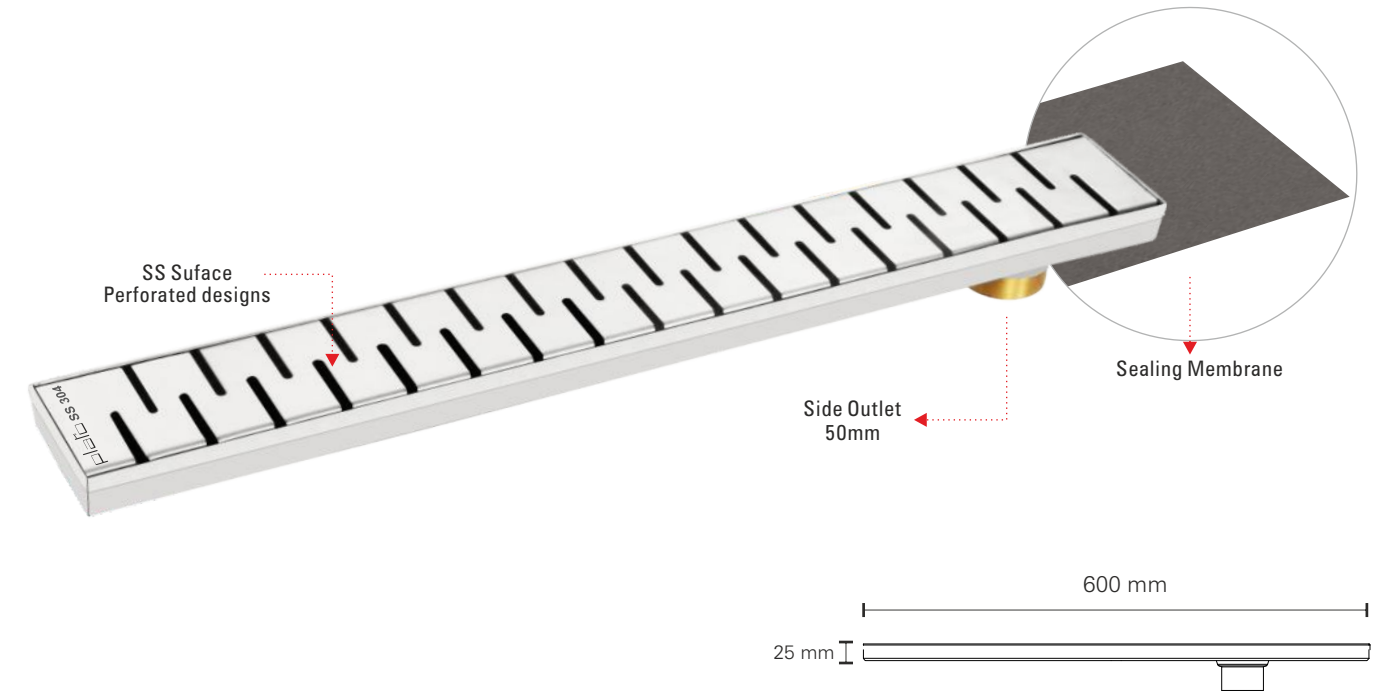

Cat No.	Size	M.R.P (₹)
WDC06901	24" (600mm)	8700/-

*Other sizes can also be Customized on Bulk Orders.

★ Life Time Quality Assurance



SPECIFICATION

-  Installation depth
90 mm
-  Drainer depth
25 mm
-  Drainage capacity
50 Ltr/min
-  Outlet
50 mm
-  Anti Cockroach
No Foul Smell
-  Hair Catcher
-  Anti Leak

TRINITY WITH BRASS COUPLER

Cat No.	Size	SS M.R.P (₹)	PVD M.R.P (₹)
7531	12" (75 x 300mm)	4200/-	6000/-
7532	18" (75 x 450mm)	5100/-	6900/-
7533	24" (75 x 600mm)	6000/-	9000/-
7534	30" (75 x 750mm)	7200/-	10500/-
7535	36" (75 x 900mm)	8400/-	12000/-
7536	40" (75 x 1000mm)	9300/-	15000/-
7537	48" (75 x 1200mm)	10800/-	18000/-

*Other sizes can also be Customized on Bulk Orders.

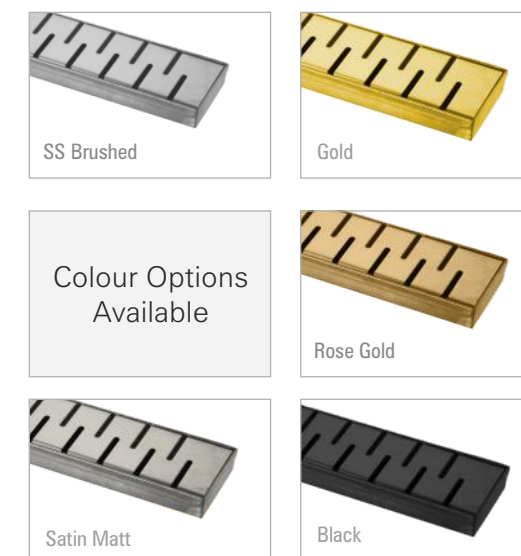



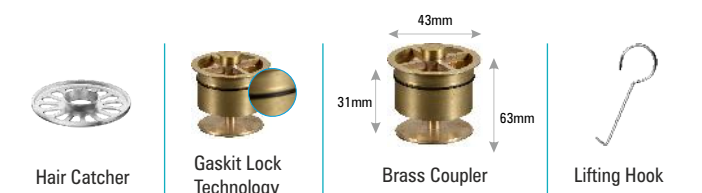

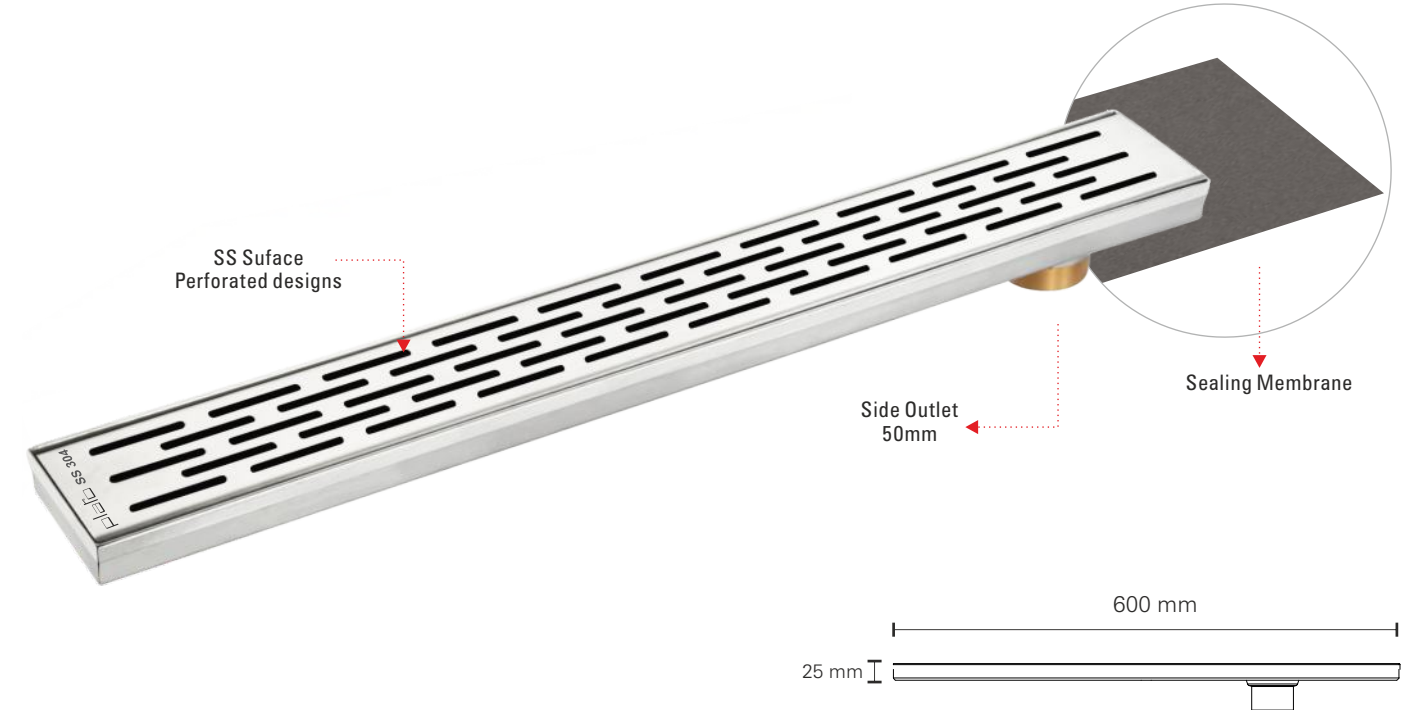

★ Life Time Quality Assurance





SPECIFICATION

-  Installation depth **90 mm**
-  Drainer depth **25 mm**
-  Drainage capacity **50 Ltr/min**
-  Outlet **50 mm**  Anti Cockroach
No Foul Smell
-  Hair Catcher
-  **NO LEAK** Anti Leak

LINEX WITH BRASS COUPLER

Cat No.	Size	SS M.R.P (₹)	PVD M.R.P (₹)
7501	12" (75 x 300mm)	4200/-	6000/-
7502	18" (75 x 450mm)	5100/-	6900/-
7503	24" (75 x 600mm)	6000/-	9000/-
7504	30" (75 x 750mm)	7200/-	10500/-
7505	36" (75 x 900mm)	8400/-	12000/-
7506	40" (75 x 1000mm)	9300/-	15000/-
7507	48" (75 x 1200mm)	10800/-	18000/-

*Other sizes can also be Customized on Bulk Orders.

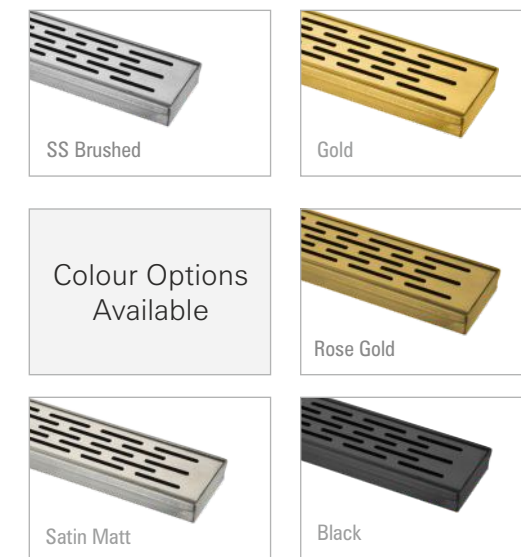



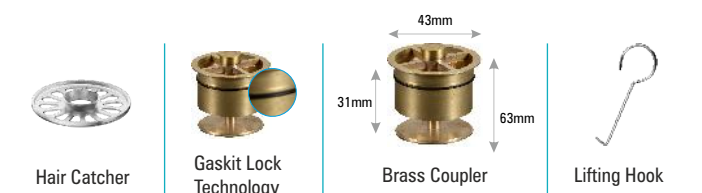

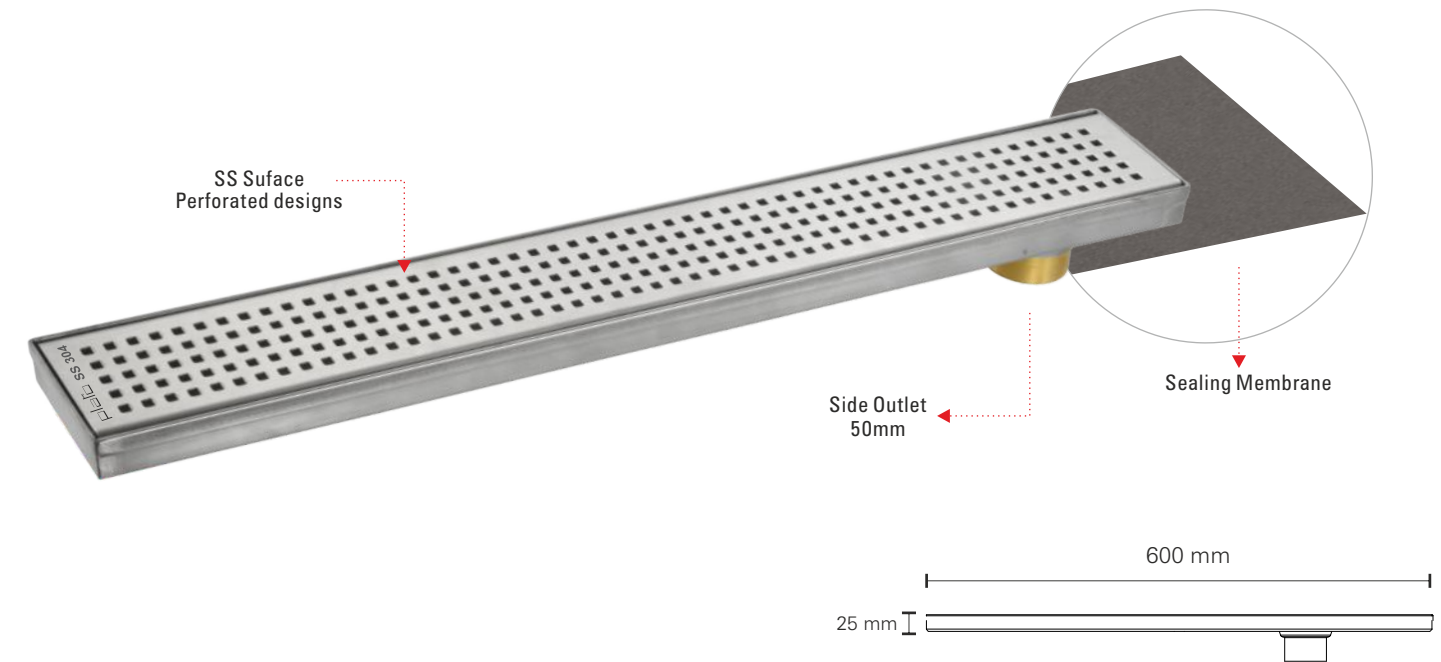
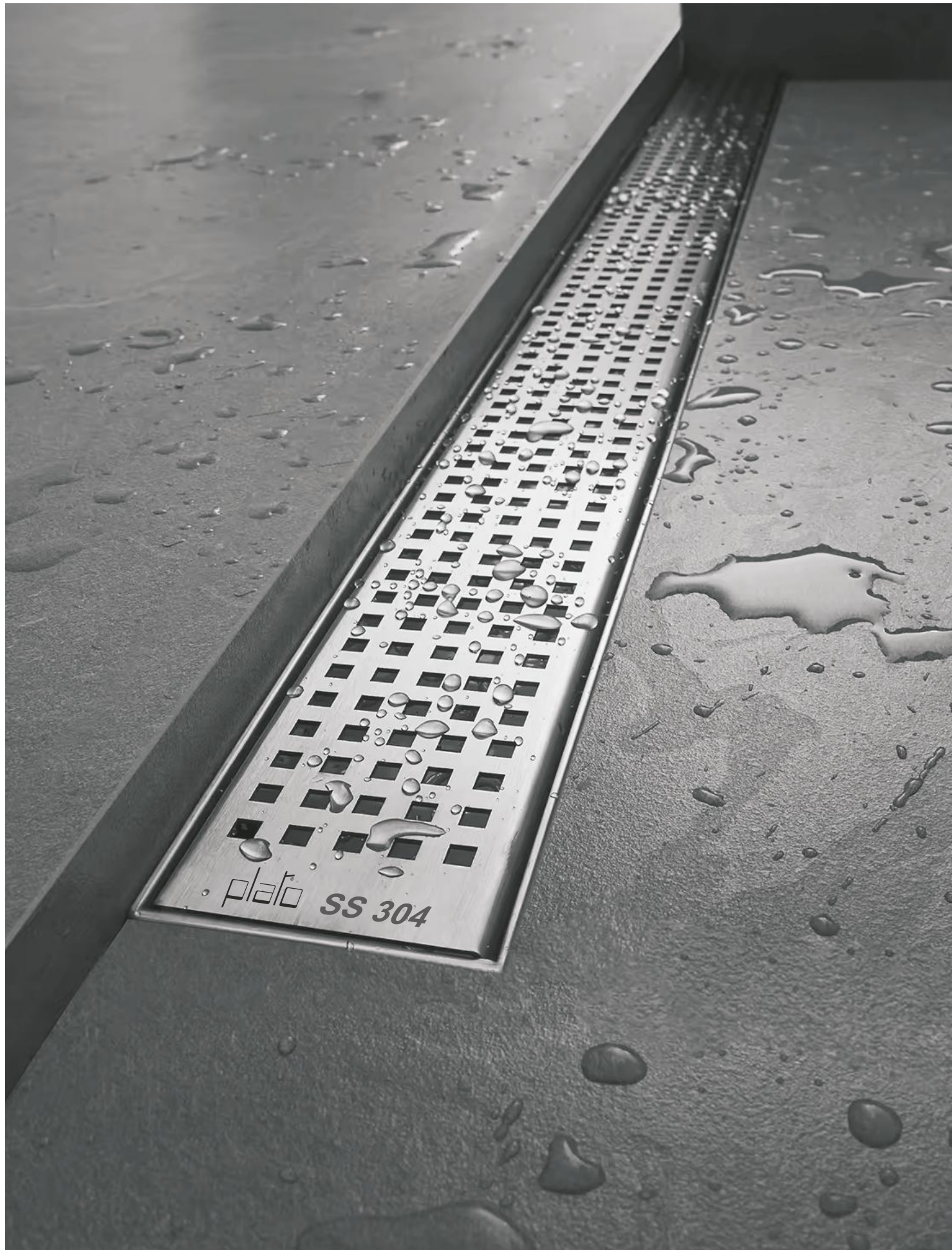

★ Life Time Quality Assurance





SPECIFICATION

-  Installation depth
90 mm
-  Drainer depth
25 mm
-  Drainage capacity
50 Ltr/min
-  Outlet
50 mm
-  Anti Cockroach
No Foul Smell
-  Hair Catcher
-  Anti Leak

BOXE WITH BRASS COUPLER

Cat No.	Size	SS M.R.P (₹)	PVD M.R.P (₹)
7561	12" (75 x 300mm)	4200/-	6000/-
7562	18" (75 x 450mm)	5100/-	6900/-
7563	24" (75 x 600mm)	6000/-	9000/-
7564	30" (75 x 750mm)	7200/-	10500/-
7565	36" (75 x 900mm)	8400/-	12000/-
7566	40" (75 x 1000mm)	9300/-	15000/-
7567	48" (75 x 1200mm)	10800/-	18000/-

*Other sizes can also be Customized on Bulk Orders.

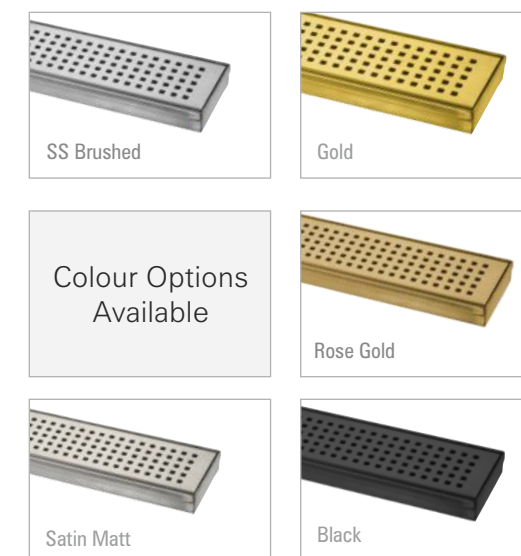



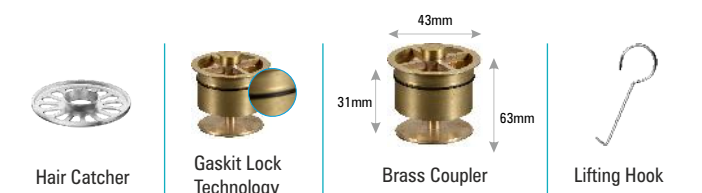

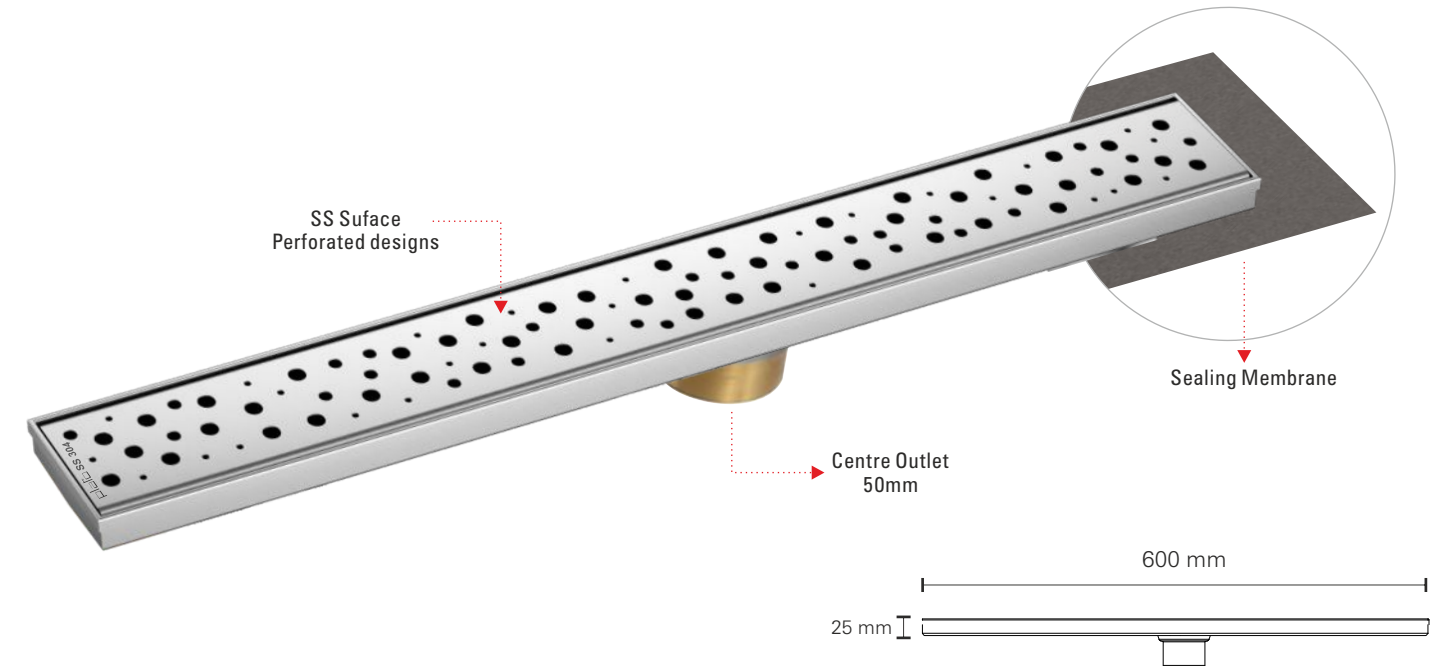
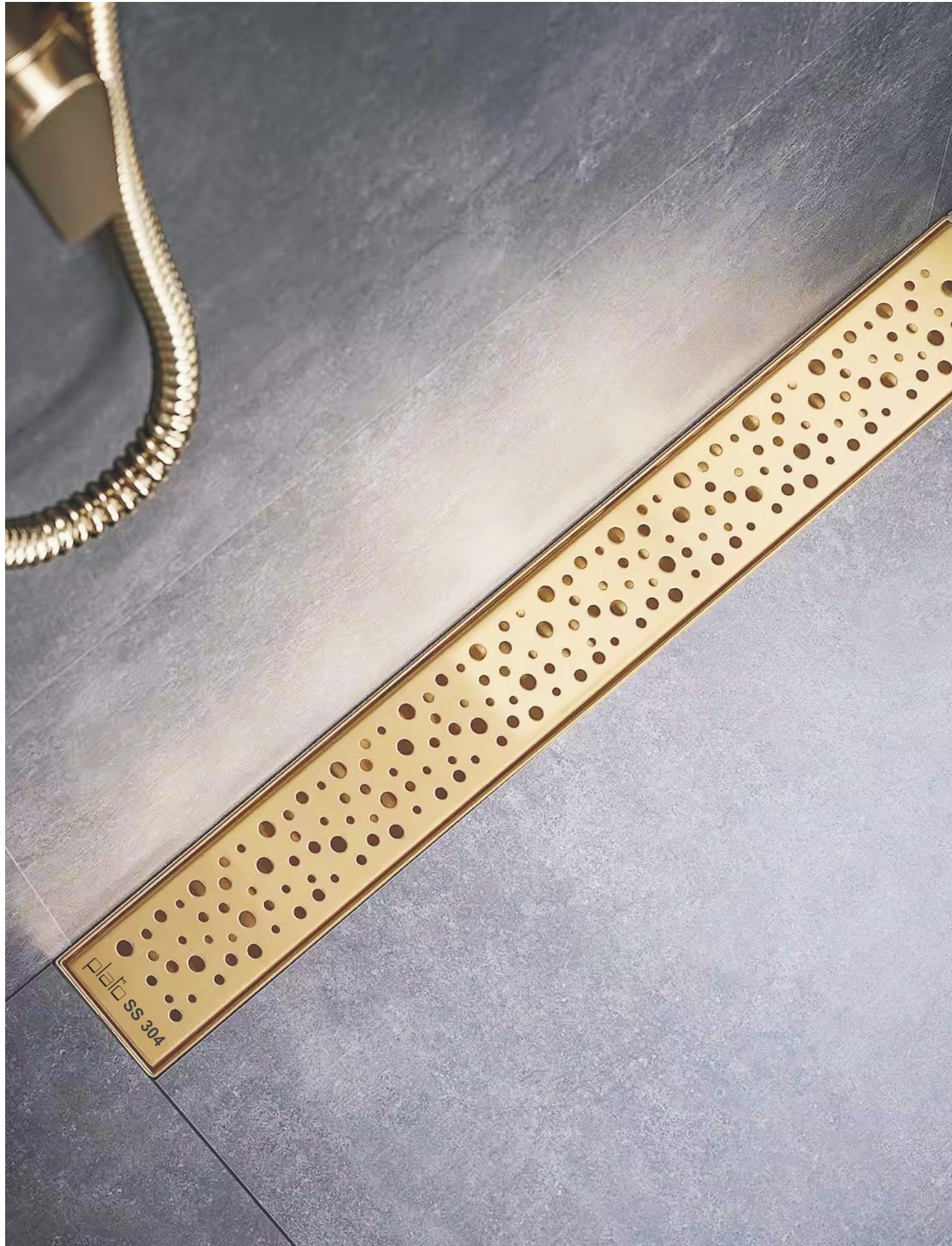

★ Life Time Quality Assurance





SPECIFICATION

-  Installation depth **90 mm**
-  Drainer depth **25 mm**
-  Drainage capacity **50 Ltr/min**
-  Outlet **50 mm**
-  Anti Cockroach
No Foul Smell
-  Hair Catcher
-  **NO LEAK** Anti Leak

GALAXY WITH BRASS COUPLER

Cat No.	Size	SS M.R.P (₹)	PVD M.R.P (₹)
7551	12" (75 x 300mm)	4200/-	6000/-
7552	18" (75 x 450mm)	5100/-	6900/-
7553	24" (75 x 600mm)	6000/-	9000/-
7554	30" (75 x 750mm)	7200/-	10500/-
7555	36" (75 x 900mm)	8400/-	12000/-
7556	40" (75 x 1000mm)	9300/-	15000/-
7557	48" (75 x 1200mm)	10800/-	18000/-

*Other sizes can also be Customized on Bulk Orders.

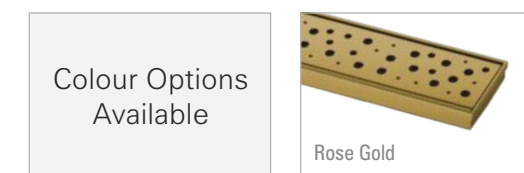

★ Life Time Quality Assurance

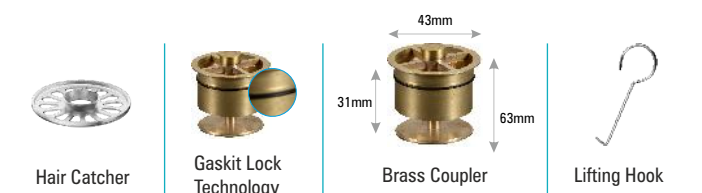

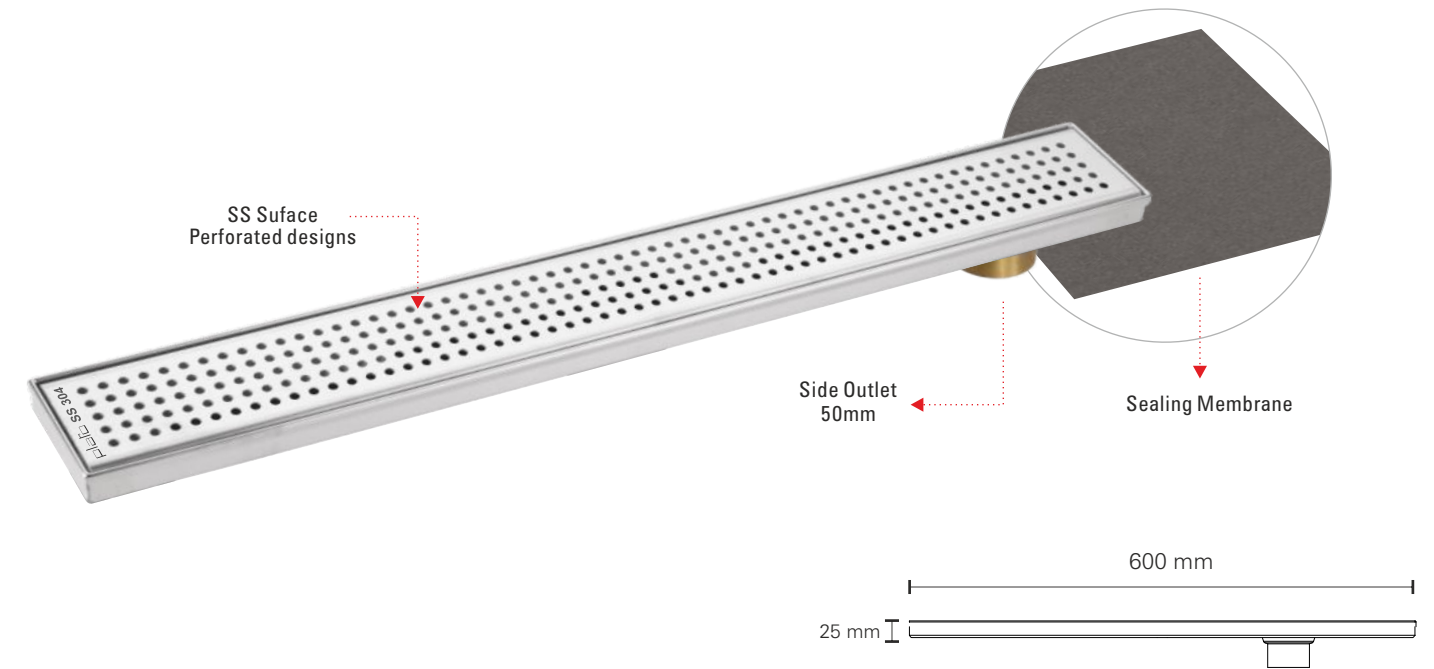

SPECIFICATION

- Installation depth **90 mm**
- Drainage capacity **50 Ltr/min**
- Hair Catcher
- Drainer depth **25 mm**
- Outlet **50 mm**
- Anti Cockroach
No Foul Smell
- NO LEAK** Anti Leak

GIRARE WITH BRASS COUPLER

Cat No.	Size	SS M.R.P (₹)	PVD M.R.P (₹)
7541	12" (75 x 300mm)	4200/-	6000/-
7542	18" (75 x 450mm)	5100/-	6900/-
7543	24" (75 x 600mm)	6000/-	9000/-
7544	30" (75 x 750mm)	7200/-	10500/-
7545	36" (75 x 900mm)	8400/-	12000/-
7546	40" (75 x 1000mm)	9300/-	15000/-
7547	48" (75 x 1200mm)	10800/-	18000/-

*Other sizes can also be Customized on Bulk Orders.

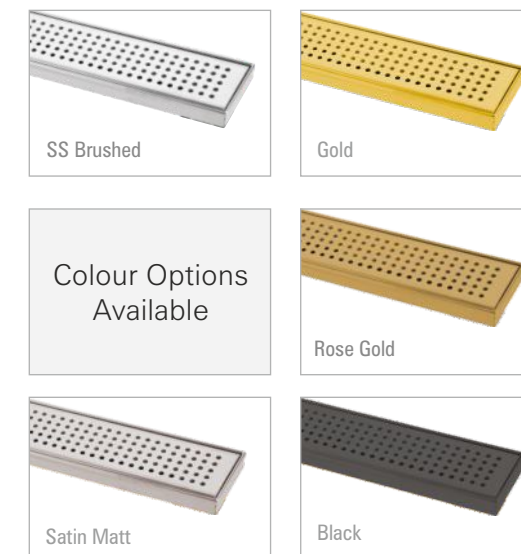

★ Life Time Quality Assurance

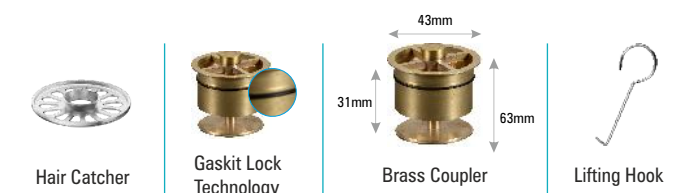



TILE INSERT DRAINER







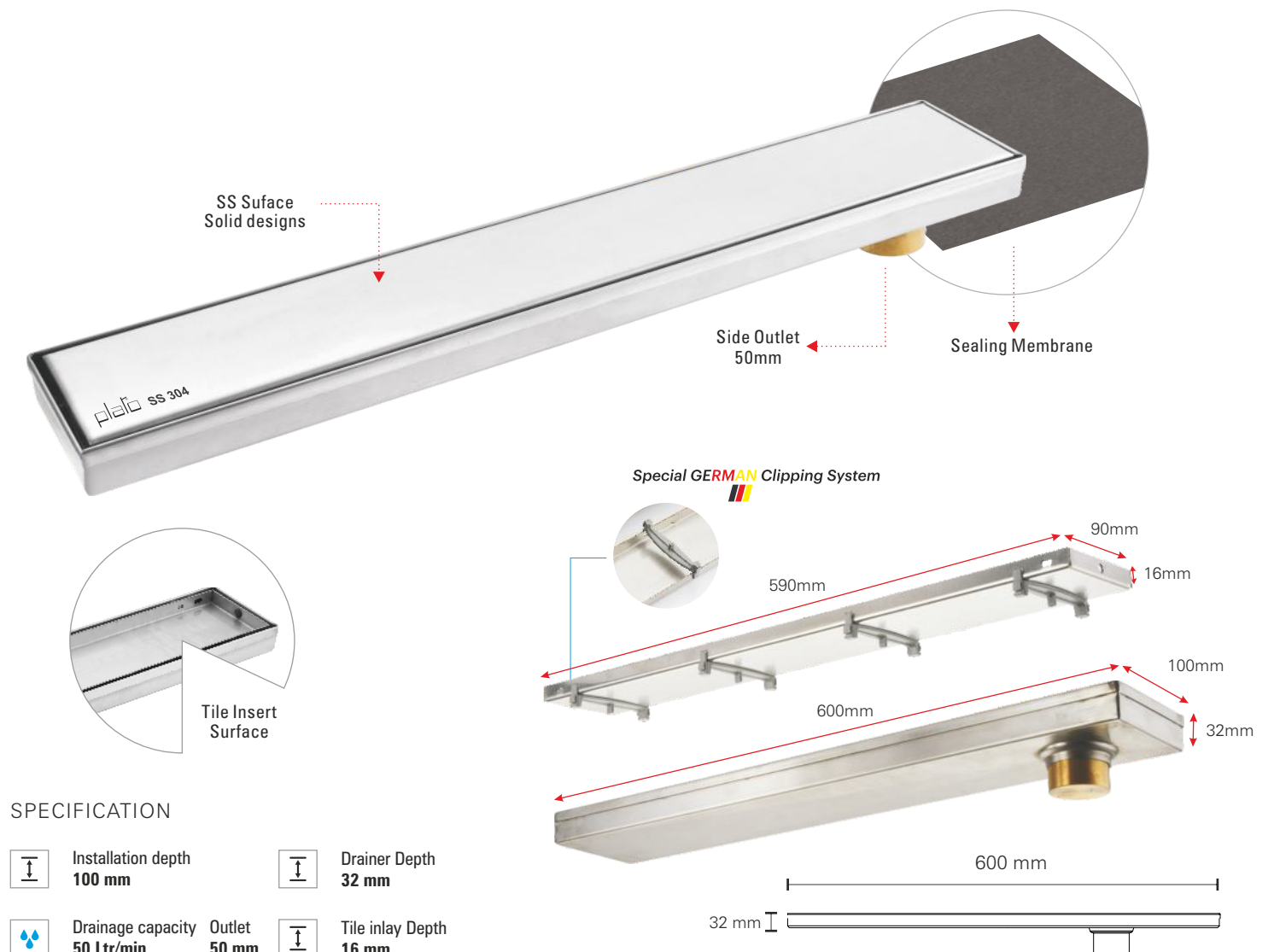

WITH CENTRE / SIDE OUTLET

GERMAN[®] TECHNOLOGY

Made of
SS 304



SPECIFICATION

-  Installation depth **100 mm**
-  Drainer Depth **32 mm**
-  Drainage capacity **50 Ltr/min**
-  Outlet **50 mm**
-  Tile inlay Depth **16 mm**
-  Anti Cockroach
No Foul Smell
-  **NO LEAK** Anti Leak
-  Hair Catcher

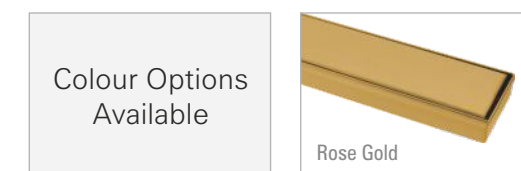

★ Life Time Quality Assurance

SOLID WITH BRASS COUPLER





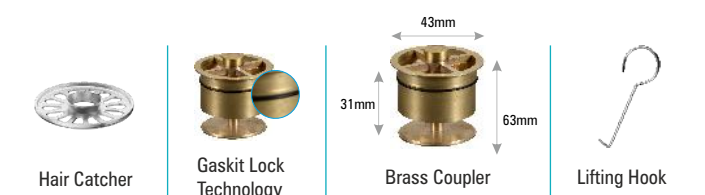

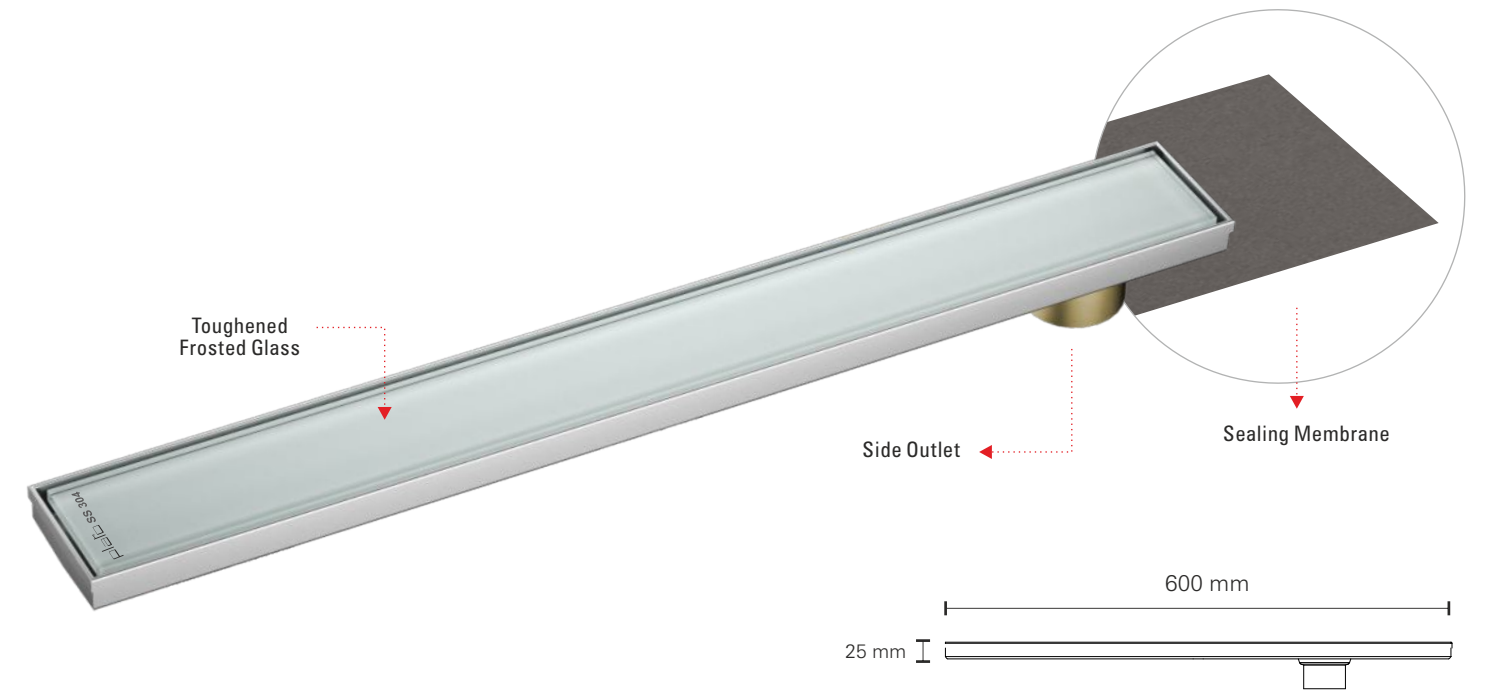
Cat No.	Size	SS M.R.P (₹)	PVD M.R.P (₹)
100T 8001	12" (100 x 300mm)	4500/-	6300/-
100T 8002	18" (100 x 450mm)	5400/-	7500/-
100T 8003	24" (100 x 600mm)	6300/-	9300/-
100T 8004	30" (100 x 750mm)	7500/-	10800/-
100T 8005	36" (100 x 900mm)	8700/-	12600/-
100T 8006	40" (100 x 1000mm)	9600/-	15000/-
100T 8007	48" (100 x 1200mm)	12000/-	18000/-

*Other sizes can also be Customized on Bulk Orders.





SPECIFICATION

-  Installation depth from **62 / 76 mm**
-  Tile inlay depth **15mm**
-  Drainage capacity **50 Ltr/min**
-  Outlet **50 mm**
-  Anti Cockroach
No Foul Smell
-  Hair Catcher
-  **NO LEAK** Anti Leak

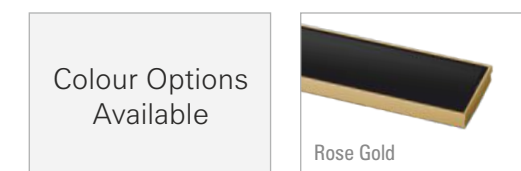
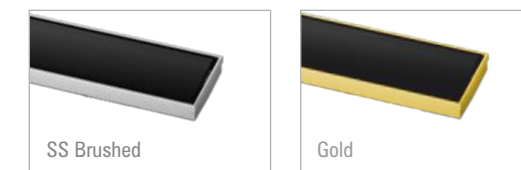

★ Life Time Quality Assurance

SOLID SURFACE WITH BRASS COUPLER

Cat No.	Size	Colour	SS M.R.P (₹)
100G8008 WH	12" (100 x 300mm)	White Glass	5400/-
100G8009 WH	18" (100 x 450mm)	White Glass	6300/-
100G8010 WH	24" (100 x 600mm)	White Glass	7500/-
100G8011 WH	30" (100 x 750mm)	White Glass	8700/-
100G8012 WH	36" (100 x 900mm)	White Glass	9600/-





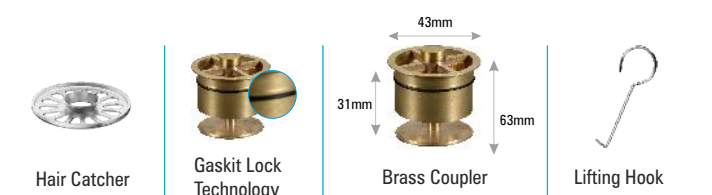

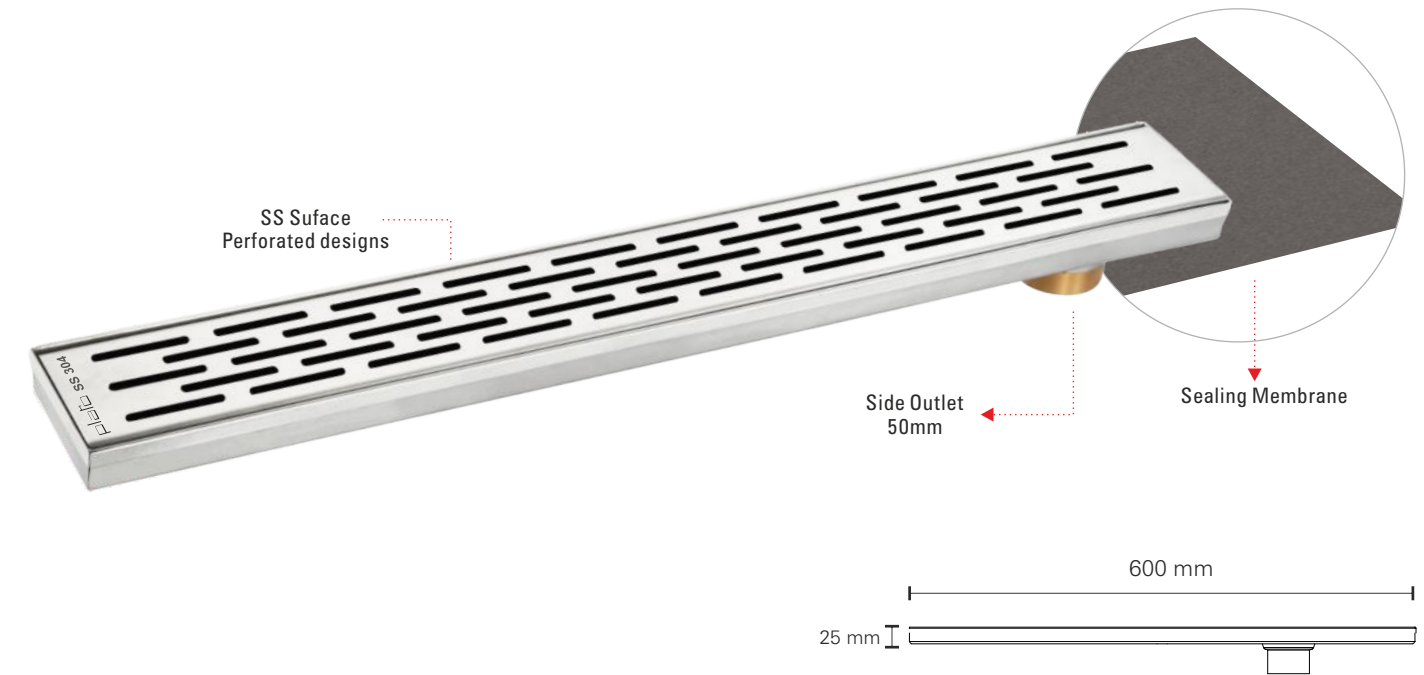
Cat No.	Size	Colour	SS M.R.P (₹)
100G8018 BK	12" (100 x 300mm)	Black Glass	5400/-
100G8019 BK	18" (100 x 450mm)	Black Glass	6300/-
100G8020 BK	24" (100 x 600mm)	Black Glass	7500/-
100G8021 BK	30" (100 x 750mm)	Black Glass	8700/-
100G8022 BK	36" (100 x 900mm)	Black Glass	9600/-

*Other sizes can also be Customized on Bulk Orders.





SPECIFICATION

-  Installation depth **90 mm**
-  Drainer depth **25 mm**
-  Drainage capacity **50 Ltr/min**
-  Outlet **50 mm**
-  Anti Cockroach
No Foul Smell
-  Hair Catcher
-  **NO LEAK** Anti Leak

LINEX WITH BRASS COUPLER

Cat No.	Size	SS M.R.P (₹)	PVD M.R.P (₹)
100W 6001	12" (100 x 300mm)	4500/-	6300/-
100W 6002	18" (100 x 450mm)	5400/-	7500/-
100W 6003	24" (100 x 600mm)	6300/-	9300/-
100W 6004	30" (100 x 750mm)	7500/-	10800/-
100W 6005	36" (100 x 900mm)	8700/-	12600/-
100W 6006	40" (100 x 1000mm)	10200/-	15000/-
100W 6007	48" (100 x 1200mm)	12000/-	18000/-

*Other sizes can also be Customized on Bulk Orders.

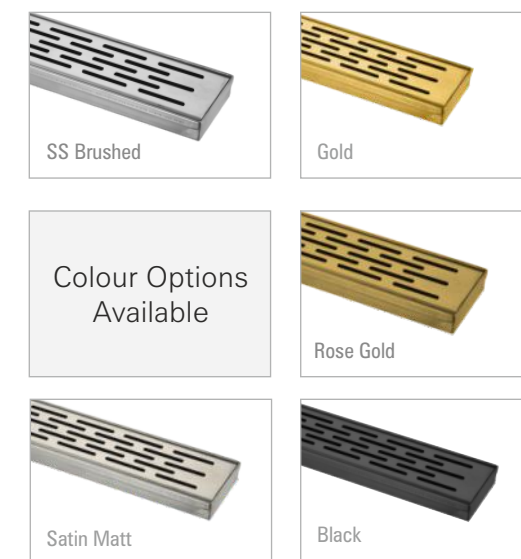

★ Life Time Quality Assurance

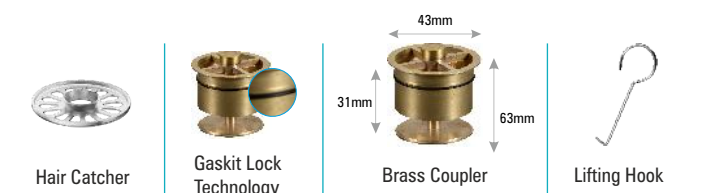

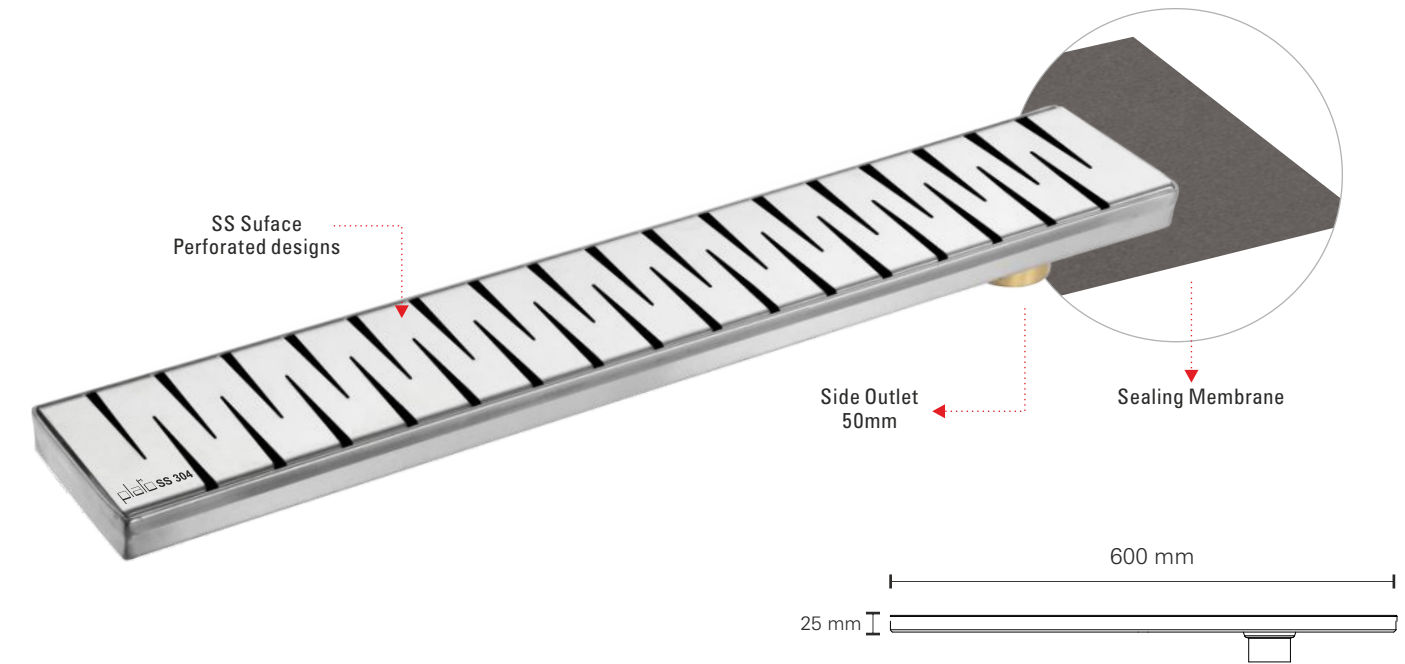

SPECIFICATION

-
-
-

Installation depth
90 mm

Drainer depth
25 mm

Drainage capacity
50 Ltr/min

Outlet
50 mm

Anti Cockroach
No Foul Smell

Hair Catcher

NO LEAK
Anti Leak

CRUZE WITH BRASS COUPLER

Cat No.	Size	SS M.R.P (₹)	PVD M.R.P (₹)
100W 6101	12" (100 x 300mm)	4500/-	6300/-
100W 6102	18" (100 x 450mm)	5400/-	7500/-
100W 6103	24" (100 x 600mm)	6300/-	9300/-
100W 6104	30" (100 x 750mm)	7500/-	10800/-
100W 6105	36" (100 x 900mm)	8700/-	12600/-
100W 6106	40" (100 x 1000mm)	10200/-	15000/-
100W 6107	48" (100 x 1200mm)	12000/-	18000/-

*Other sizes can also be Customized on Bulk Orders.

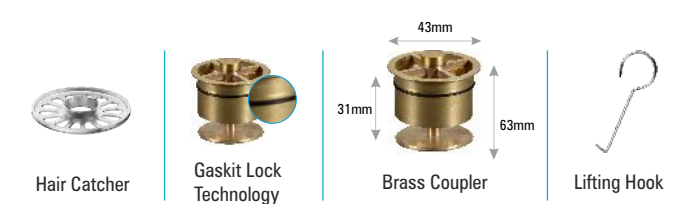
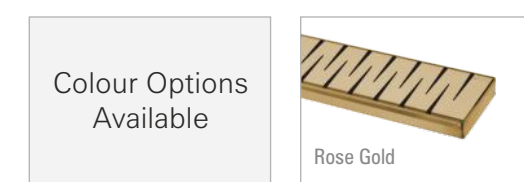
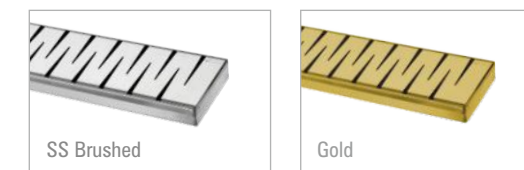

★ Life Time Quality Assurance

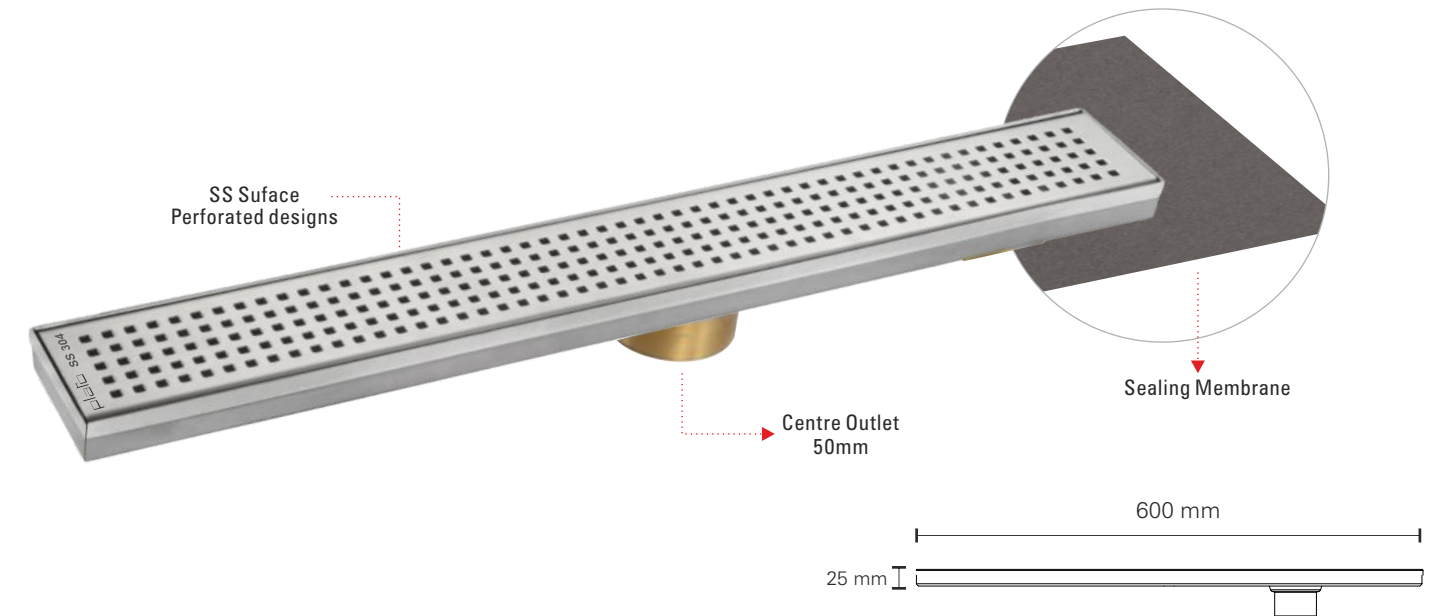

SPECIFICATION

- Installation depth **90 mm**
- Drainer depth **25 mm**
- Drainage capacity **50 Ltr/min**
- Outlet **50 mm** Anti Cockroach No Foul Smell
- Hair Catcher
- NO LEAK** Anti Leak

BOXE WITH BRASS COUPLER

Cat No.	Size	SS M.R.P (₹)	PVD M.R.P (₹)
100W 6061	12" (100 x 300mm)	4500/-	6300/-
100W 6062	18" (100 x 450mm)	5400/-	7500/-
100W 6063	24" (100 x 600mm)	6300/-	9300/-
100W 6064	30" (100 x 750mm)	7500/-	10800/-
100W 6065	36" (100 x 900mm)	8700/-	12600/-
100W 6066	40" (100 x 1000mm)	10200/-	15000/-
100W 6067	48" (100 x 1200mm)	12000/-	18000/-



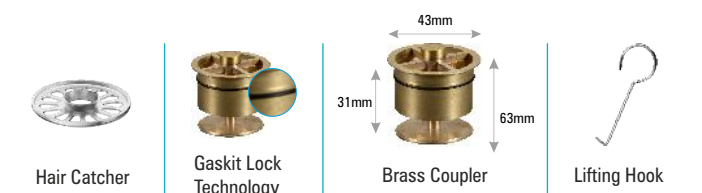
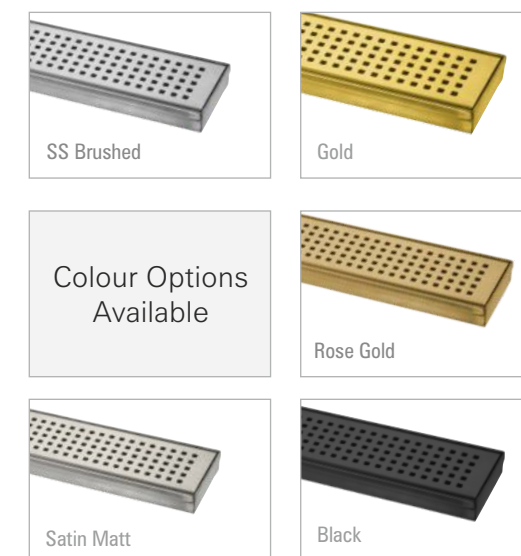

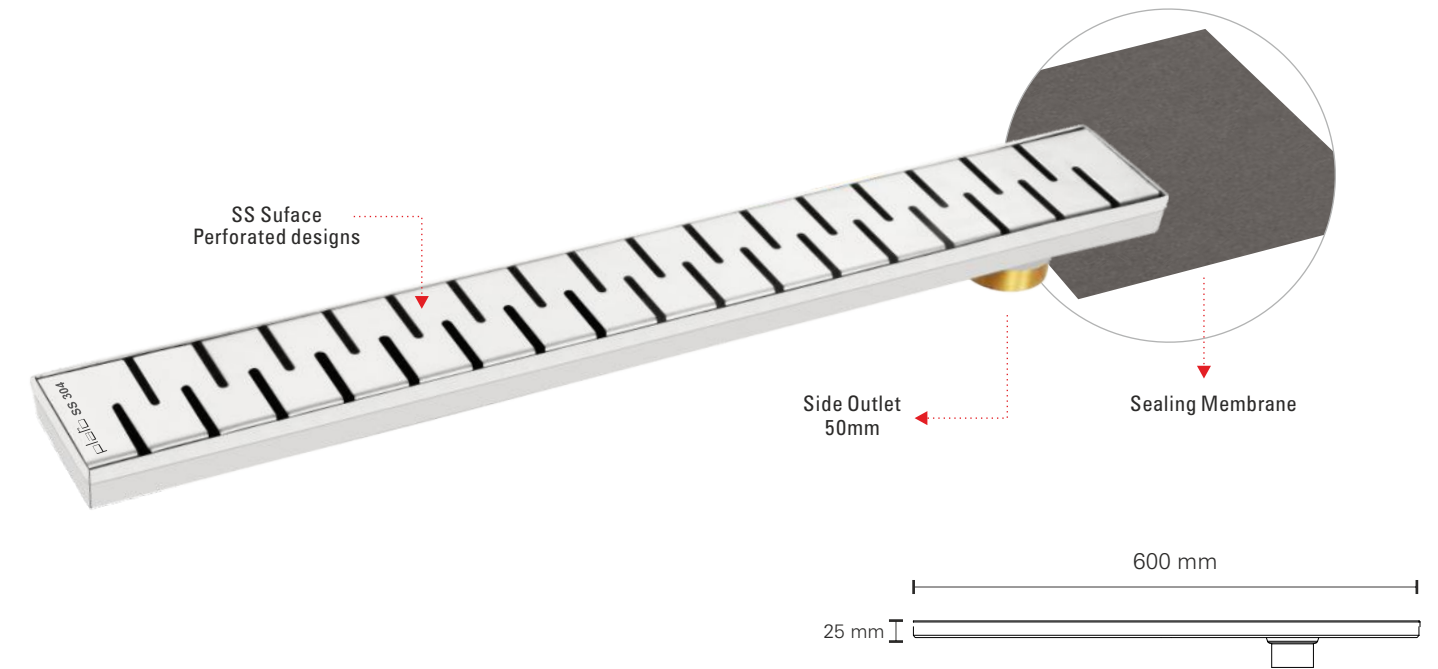

*Other sizes can also be Customized on Bulk Orders.



★ Life Time Quality Assurance



SPECIFICATION

-  Installation depth **90 mm**
-  Drainer depth **25 mm**
-  Drainage capacity **50 Ltr/min**
-  Outlet **50 mm**
-  Anti Cockroach
No Foul Smell
-  Hair Catcher
-  **NO LEAK** Anti Leak

TRINITY WITH BRASS COUPLER

Cat No.	Size	SS M.R.P (₹)	PVD M.R.P (₹)
100W 6031	12" (100 x 300mm)	4500/-	6300/-
100W 6032	18" (100 x 450mm)	5400/-	7500/-
100W 6033	24" (100 x 600mm)	6300/-	9300/-
100W 6034	30" (100 x 750mm)	7500/-	10800/-
100W 6035	36" (100 x 900mm)	8700/-	12600/-
100W 6036	40" (100 x 1000mm)	10200/-	15000/-
100W 6037	48" (100 x 1200mm)	12000/-	18000/-

*Other sizes can also be Customized on Bulk Orders.

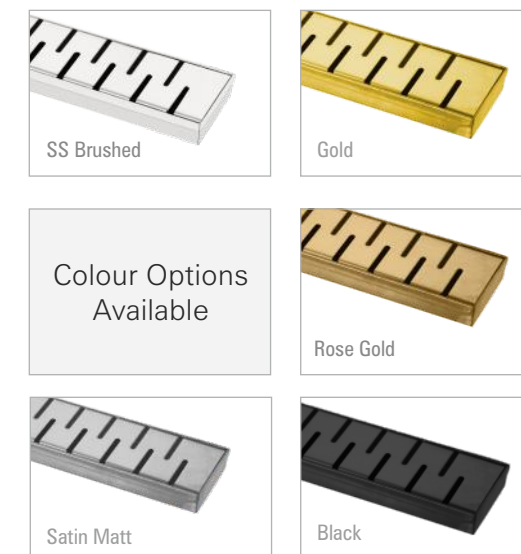

★ Life Time Quality Assurance

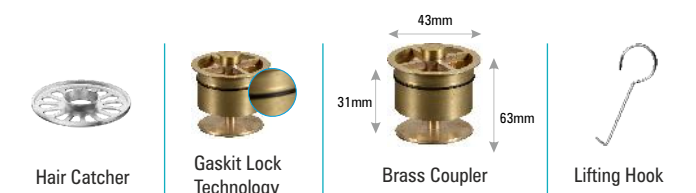









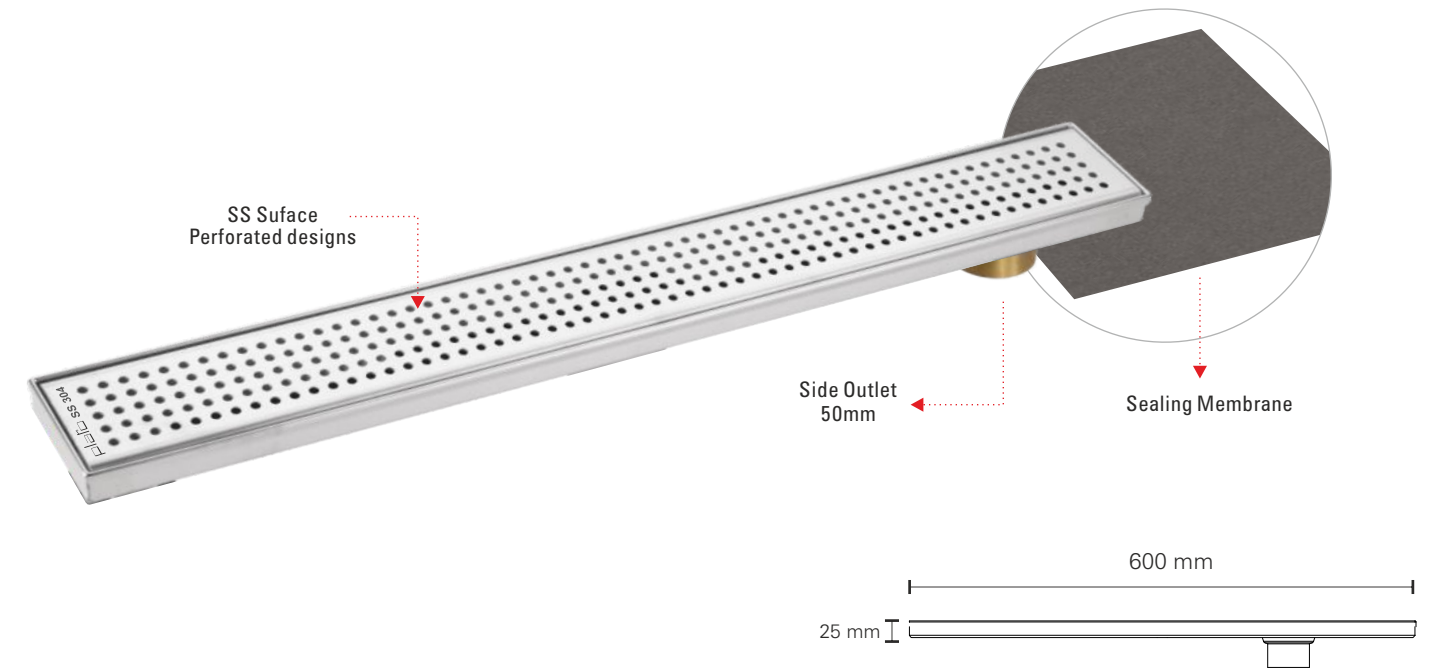

SHOWER DRAINER
WITH CENTRE / SIDE OUTLET

GERMAN TECHNOLOGY

Made of
SS 304



SPECIFICATION

-  Installation depth **90 mm**
-  Drainer depth **25 mm**
-  Drainage capacity **50 Ltr/min**
-  Outlet **50 mm**
-  Anti Cockroach
No Foul Smell
-  Hair Catcher
-  Anti Leak

GIRARE WITH BRASS COUPLER

Cat No.	Size	SS M.R.P (₹)	PVD M.R.P (₹)
100W 6041	12" (100 x 300mm)	4500/-	6300/-
100W 6042	18" (100 x 450mm)	5400/-	7500/-
100W 6043	24" (100 x 600mm)	6300/-	9300/-
100W 6044	30" (100 x 750mm)	7500/-	10800/-
100W 6045	36" (100 x 900mm)	8700/-	12600/-
100W 6046	40" (100 x 1000mm)	10200/-	15000/-
100W 6047	48" (100 x 1200mm)	12000/-	18000/-

*Other sizes can also be Customized on Bulk Orders.

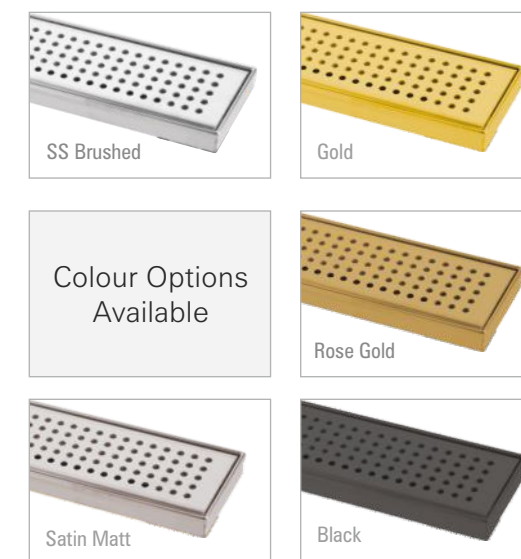



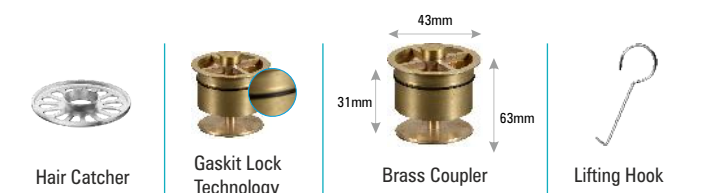

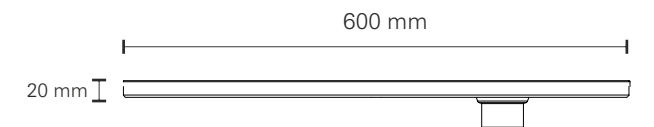
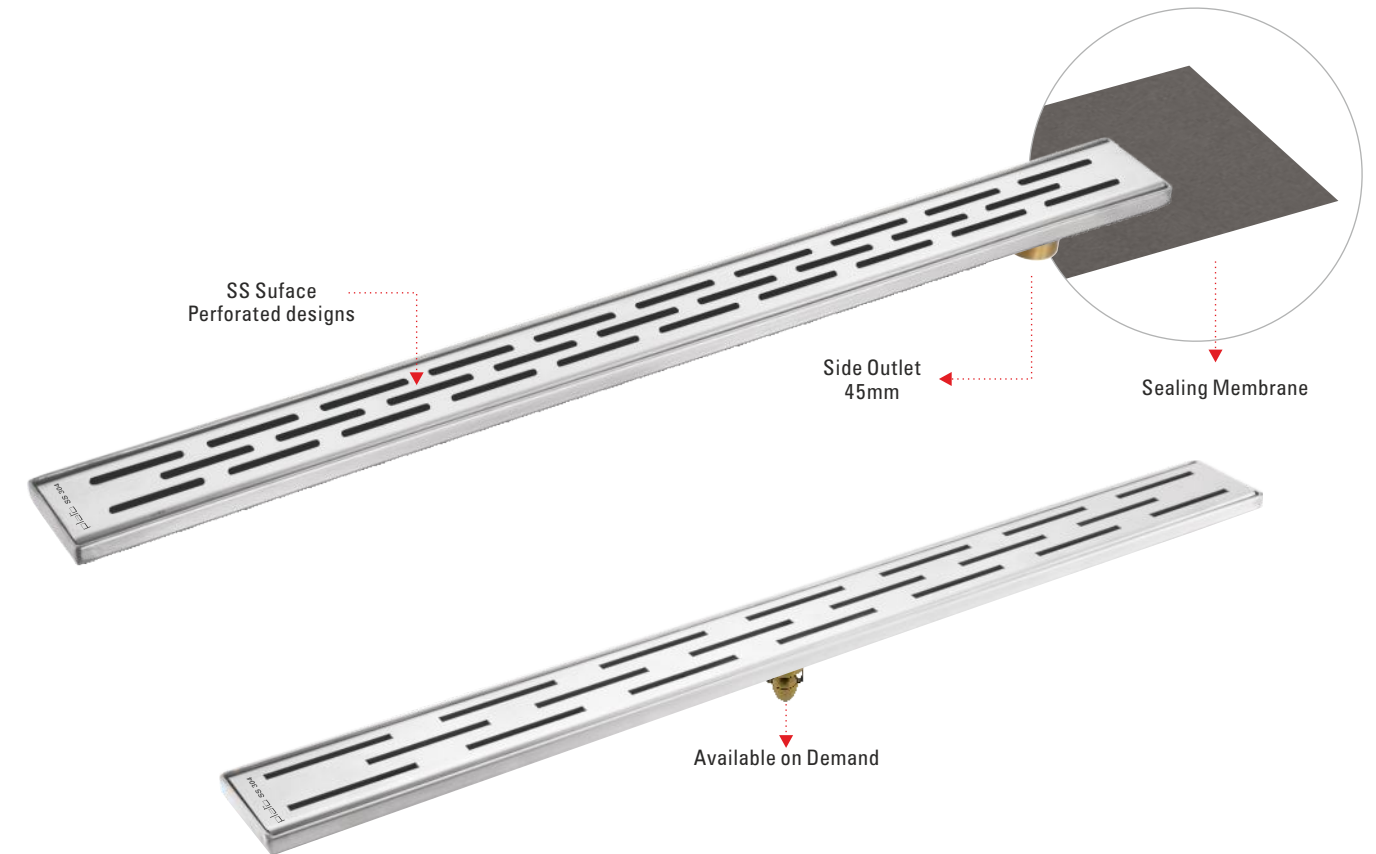

★ Life Time Quality Assurance





SPECIFICATION

-  Installation depth **90 mm**
-  Drainer depth **20 mm**
-  Drainage capacity **36 Ltr/min**
-  Outlet **45 mm**
-  Anti Cockroach
No Foul Smell
-  Hair Catcher
-  **NO LEAK** Anti Leak

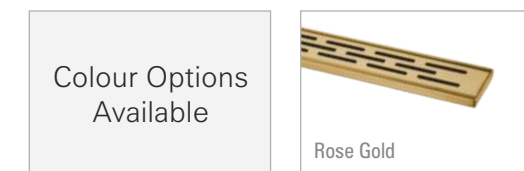
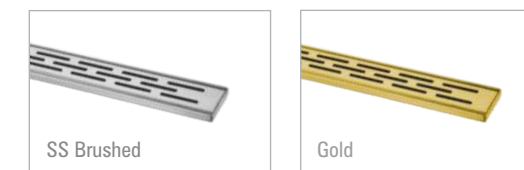

LINEX WITH BRASS COUPLER

Cat No.	Size	SS M.R.P (₹)	PVD M.R.P (₹)
60W 4002	18" (60 x 450mm)	3900/-	6600/-
60W 4003	24" (60 x 600mm)	4800/-	8400/-
60W 4004	30" (60 x 750mm)	5700/-	9900/-



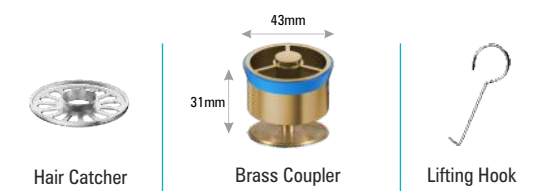

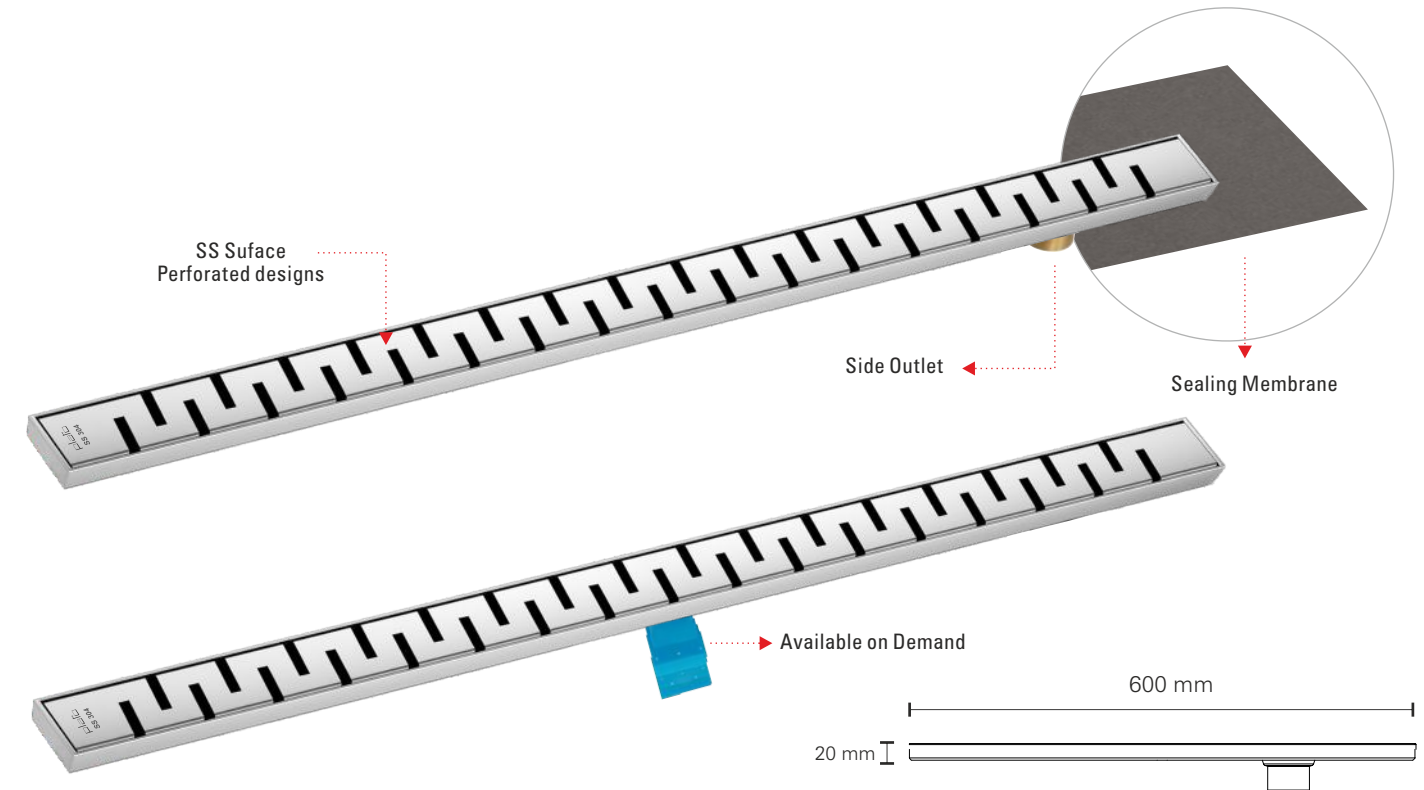

*Other sizes can also be Customized on Bulk Orders.



★ Life Time Quality Assurance



SPECIFICATION

-  Installation depth **90 mm**
-  Drainer depth **20 mm**
-  Drainage capacity **36 Ltr/min**
-  Outlet **45 mm**
-  Anti Cockroach
No Foul Smell
-  Hair Catcher
-  **NO LEAK** Anti Leak

TRINITY WITH BRASS COUPLER

Cat No.	Size	SS M.R.P (₹)	PVD M.R.P (₹)
60W 4032	18" (60 x 450mm)	3900/-	6600/-
60W 4033	24" (60 x 600mm)	4800/-	8400/-
60W 4034	30" (60 x 750mm)	5700/-	9900/-

*Other sizes can also be Customized on Bulk Orders.

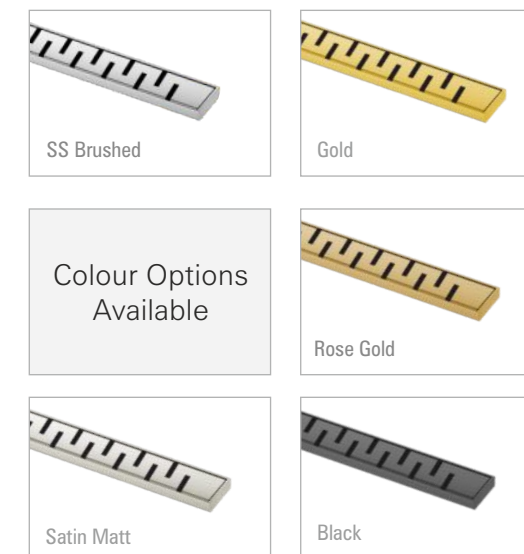

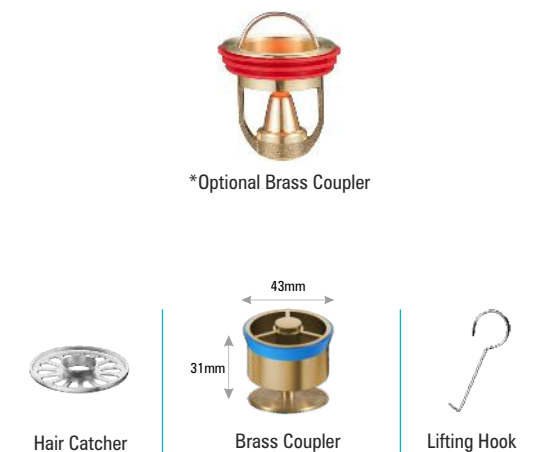

★ Life Time Quality Assurance

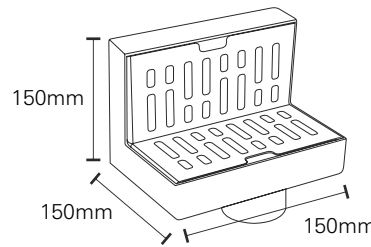

SCUPPER DRAIN ROOF DRAIN



SPECIFICATION



-  Installation depth **70mm**
-  Anti Cockroach
No Foul Smell
-  Drainage capacity (free) **250 Ltr/min**
-  Anti Leak

Heavy Duty Roof Drainer with Brass Coupler

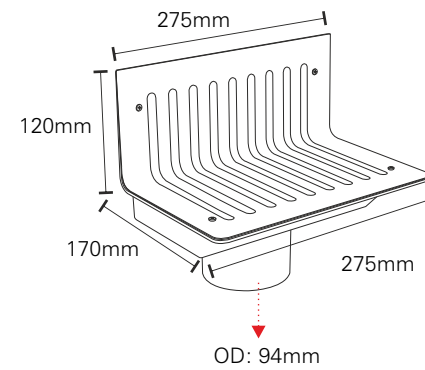
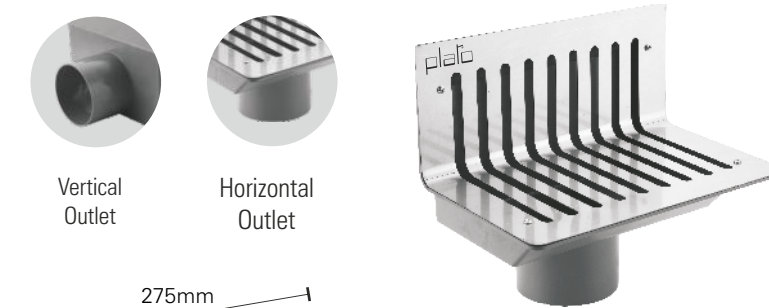
Cat No.	Size (mm)	Size (inch)	M.R.P (₹)
RD 3001	125 x 125 x 125mm	5" x 5" x 5"	3600/-
RD 3002	150 x 150 x 150mm	6" x 6" x 6"	5100/-
RD 3003	200 x 200 x 200mm	8" x 8" x 8"	8400/-



SPECIFICATION

-  Installation depth **70mm**
-  Anti Cockroach
No Foul Smell
-  Drainage capacity (free) **500 Ltr/min**
-  Anti Leak

Heavy Duty Roof Drainer with Brass Coupler

Cat No.	Size (mm)	Size (inch)	M.R.P (₹)
RD 3103	275 x 275 x 170mm	11" x 11" x 6.75"	3900/-

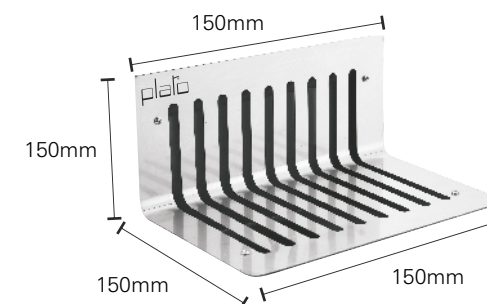

Heavy Duty Roof Drainer

Cat No.	Size (mm)	Size (inch)	M.R.P (₹)
RD 3202	150 x 150 x 150mm	6" x 6" x 6"	1530/-

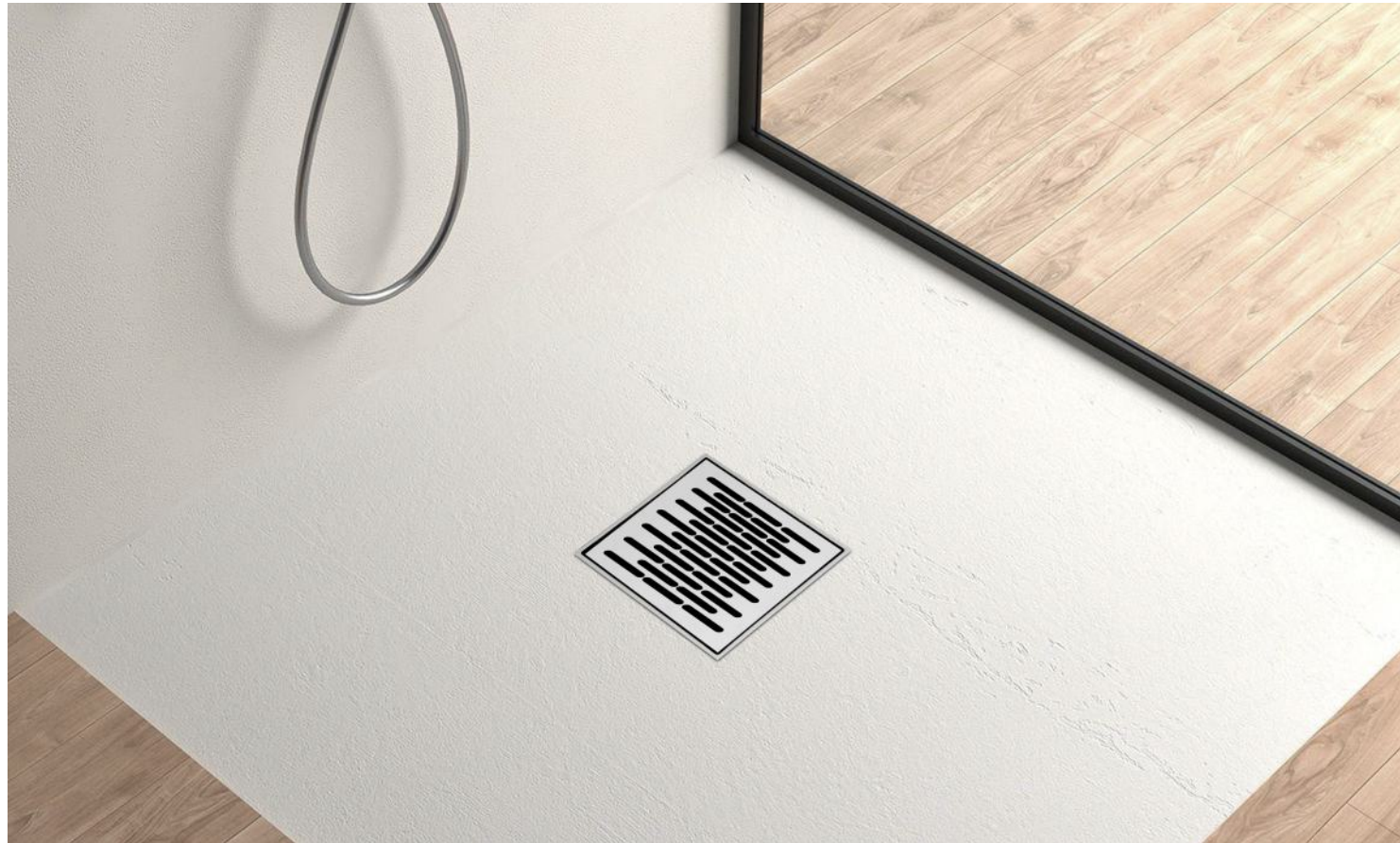

SS SQUARE FLOOR DRAINER

GERMAN[®] TECHNOLOGY

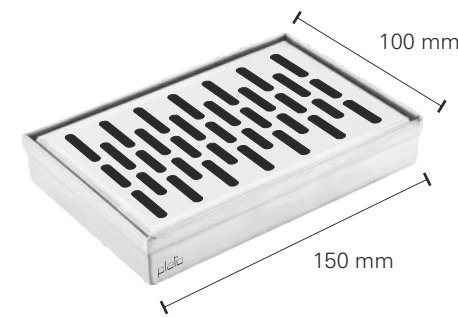
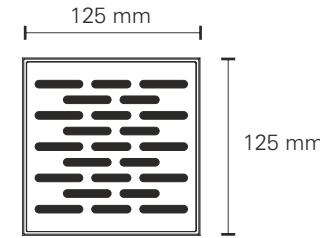
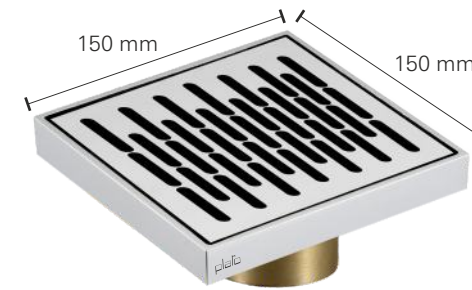

SPECIFICATION

-  Installation depth **100 mm**
-  Drainage capacity **50 Ltr/min**
-  Anti Cockroach
No Foul Smell
-  **NO LEAK** Anti Leak

Heavy Duty Shower Drainer with Brass Coupler

Cat No.	Size (mm)	Size (inch)	SS M.R.P	PVD M.R.P
DB 3201	125 x 125mm	5" x 5"	2050/-	3300/-
DB 3202	150 x 150mm	6" x 6"	2400/-	4200/-
DB 3203	100 x 150mm	4" x 6"	2050/-	3300/-

SS CORNER DRAINER

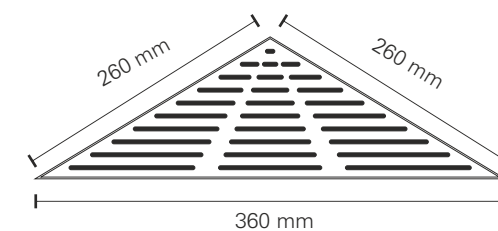
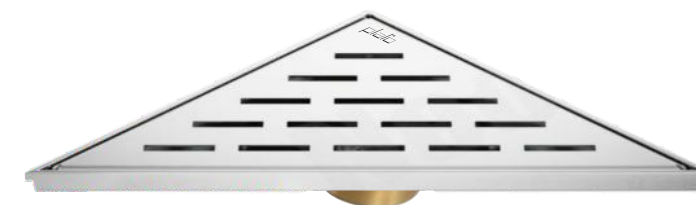

SPECIFICATION

-  Installation depth **100 mm**
-  Drainage capacity **50 Ltr/min**
-  Anti Cockroach
No Foul Smell
-  **NO LEAK** Anti Leak

Corner Drainer

Cat No.	Size (mm)	Size (inch)	SS M.R.P	PVD M.R.P
DBC 3301	260x260x360 mm	10" x 10" x 14"	3600/-	6000/-



LANZO

SPECIFICATION

- Installation depth **18 mm**
- Drainage capacity (free) **32 Ltr/min (40mm)**
- Anti Cockroach No Foul Smell
- NO LEAK Anti Leak

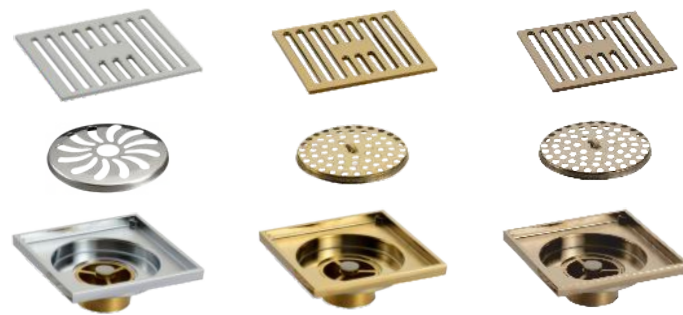
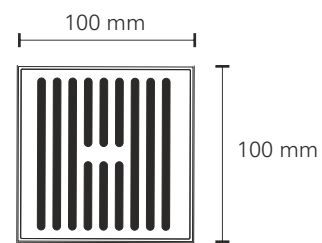

Hvy. Duty LANZO Drainer with Brass Coupler & Hair Catcher

Cat No.	Size (mm)	Size (inch)	Colour	M.R.P (₹)
DB 3401	100 x 100mm	4"x4"	Chrome	3000/-
DB 3401 GD	100 x 100mm	4"x4"	Gold	4200/-
DB 3401 RG	100 x 100mm	4"x4"	Rose Gold	4200/-



Gold PVD



Rose Gold PVD



SALWEEN

SPECIFICATION

- Installation depth **08 mm**
- Drainage capacity (free) **32 Ltr/min (40mm)**
- Anti Cockroach No Foul Smell
- NO LEAK Anti Leak

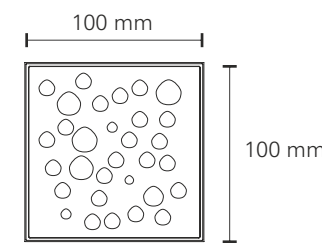

Hvy. Duty SALWEEN Drainer with Brass Coupler & Hair Catcher

Cat No.	Size (mm)	Size (inch)	Colour	M.R.P (₹)
DB 3410	100 x 100mm	4"x4"	Chrome	3000/-
DB 3410 GD	100 x 100mm	4"x4"	Gold	4200/-
DB 3410 RG	100 x 100mm	4"x4"	Rose Gold	4200/-



Gold PVD





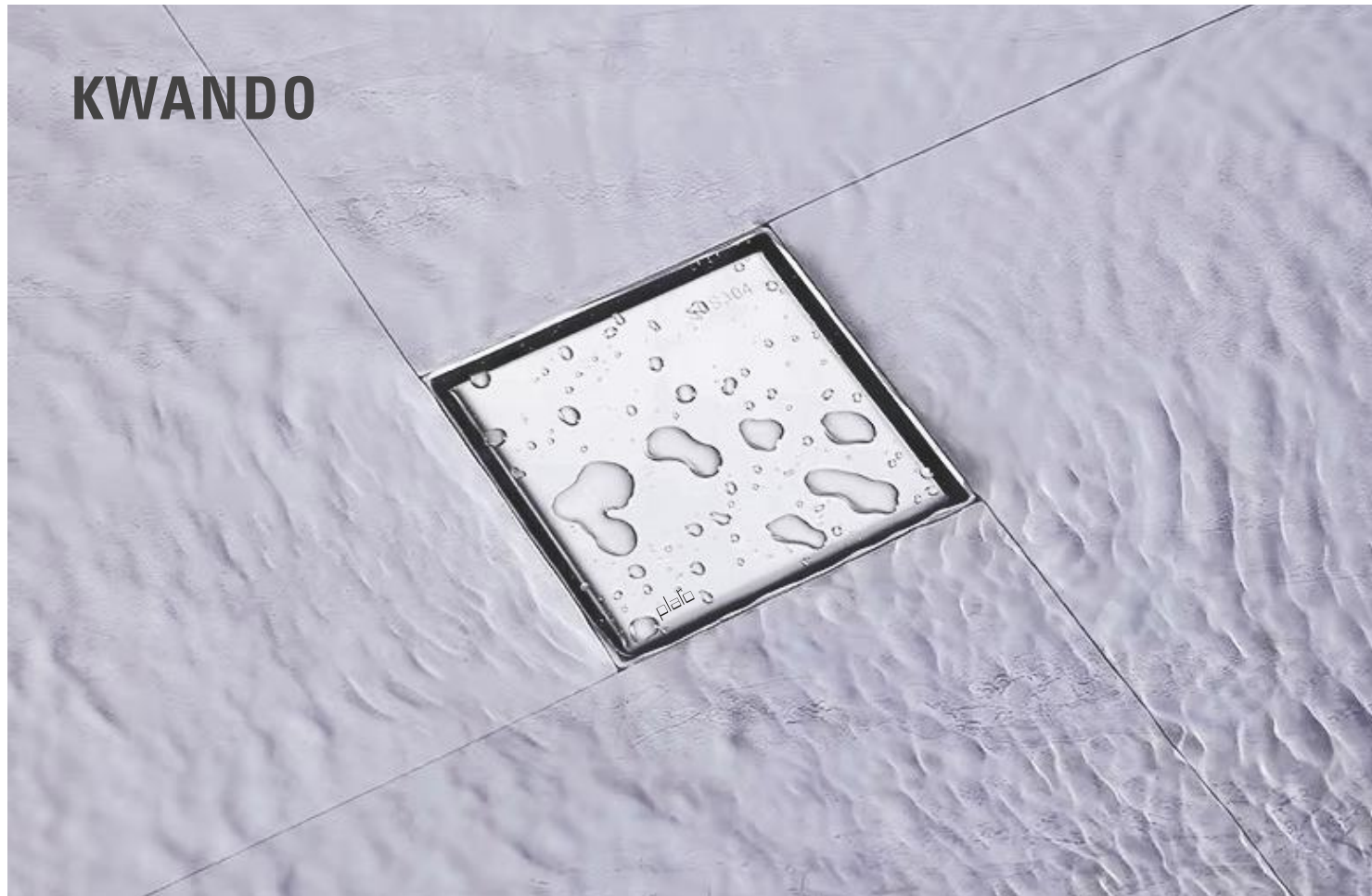

Rose Gold PVD

KWANDO



SPECIFICATION

-  Installation depth **18 mm**
-  Anti Cockroach
No Foul Smell
-  Drainage capacity (free) **32 Ltr/min (40mm)**
-  **NO LEAK** Anti Leak

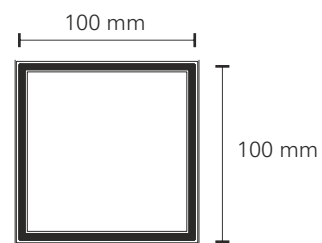

Hvy. Duty KWANDO Drainer with Brass Coupler & Hair Catcher

Cat No.	Size (mm)	Size (inch)	Colour	M.R.P (₹)
DB 3420	100 x 100mm	4" x 4"	Chrome	3600/-
DB 3420 GD	100 x 100mm	4" x 4"	Gold	4200/-
DB 3420 RG	100 x 100mm	4" x 4"	Rose Gold	4200/-

Gold PVD

Rose Gold PVD







Corner Balcony Drainer

Cat No.	Size (mm)	M.R.P (₹)
BD 3901	182 x 182 x 124mm	960/-
BD 3902	130 x 130 x 122mm	450/-

INTRODUCING



SPECIFICATION

-  Installation depth from **68 -126 mm**
-  Anti Cockroach
No Foul Smell
-  Drainage capacity (free) **50Ltr/min**
-  **NO LEAK** Anti Leak

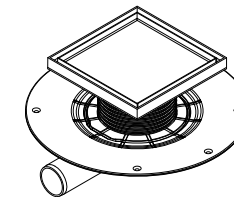
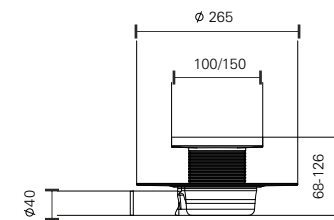



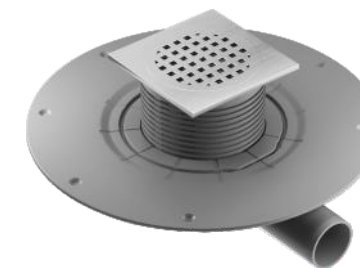

Spl. Tile Drainer with Outlet Attachent

Cat No.	Size (mm)	Size (inch)	M.R.P (₹)
SD 3801	150 x 150mm	6" x 6"	4500/-

INTRODUCING



SPECIFICATION

-  Installation depth from **68 -126 mm**
-  Anti Cockroach
No Foul Smell
-  Drainage capacity (free) **50Ltr/min**
-  **NO LEAK** Anti Leak

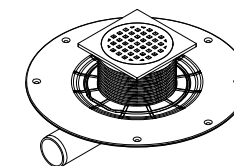
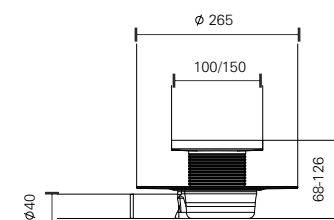

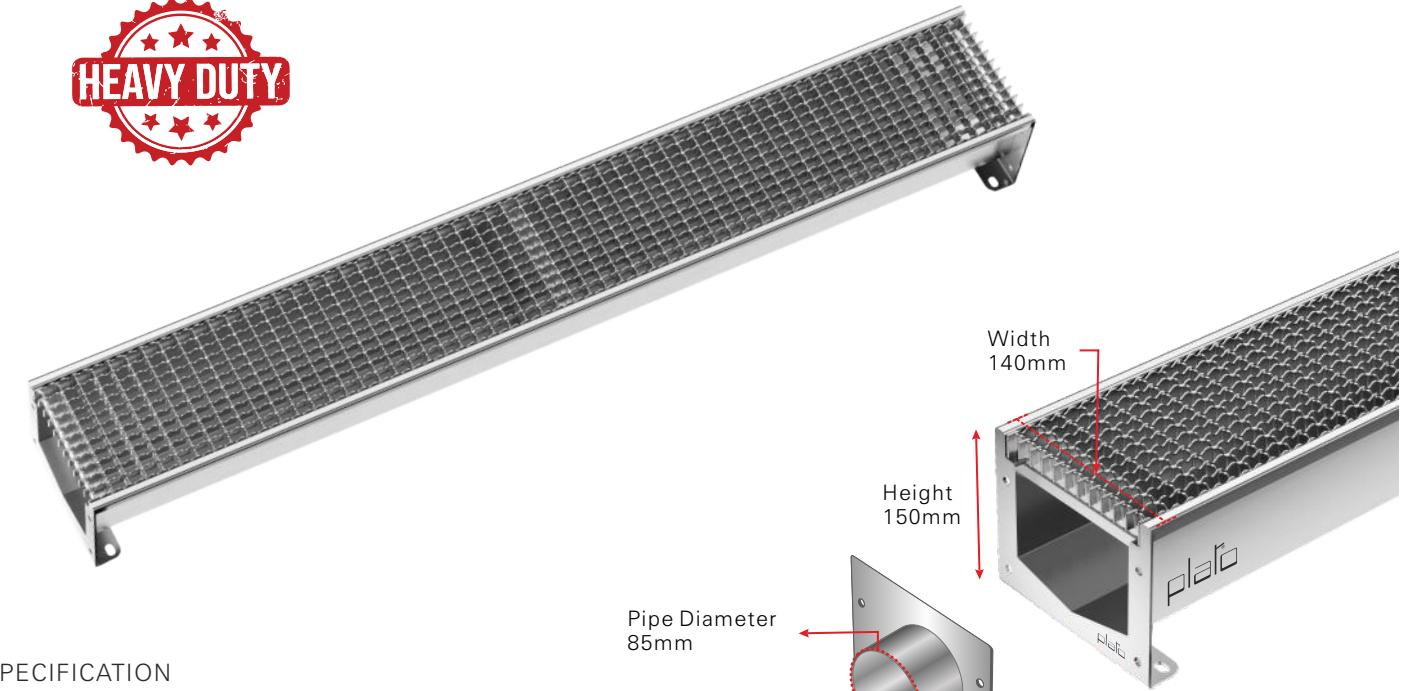

Spl. Tile Drainer with Outlet Attachent

Cat No.	Size (mm)	Size (inch)	M.R.P (₹)
SD 3802	150 x 150mm	6" x 6"	5100/-



SPECIFICATION

-  Installation depth
150 mm
-  Drainage capacity
250 Ltr/min



Pipe Diameter
85mm

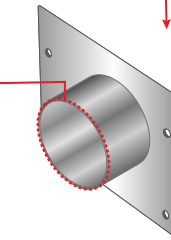

APPLICATION

- Restaurant's Kitchen
- Parking
- Swimming Pool
- Hotels / Hospitals
- Supermarket, Mall & etc.

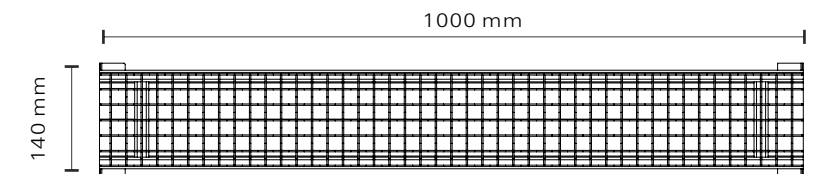

Spl. Heavy Duty Commercial Shower Drainer (**JUMBO**)

Cat No.	Size (mm)	Size (inch)	M.R.P (₹) per mtr.
140KD 2001	140x1000	40"	51000/- set

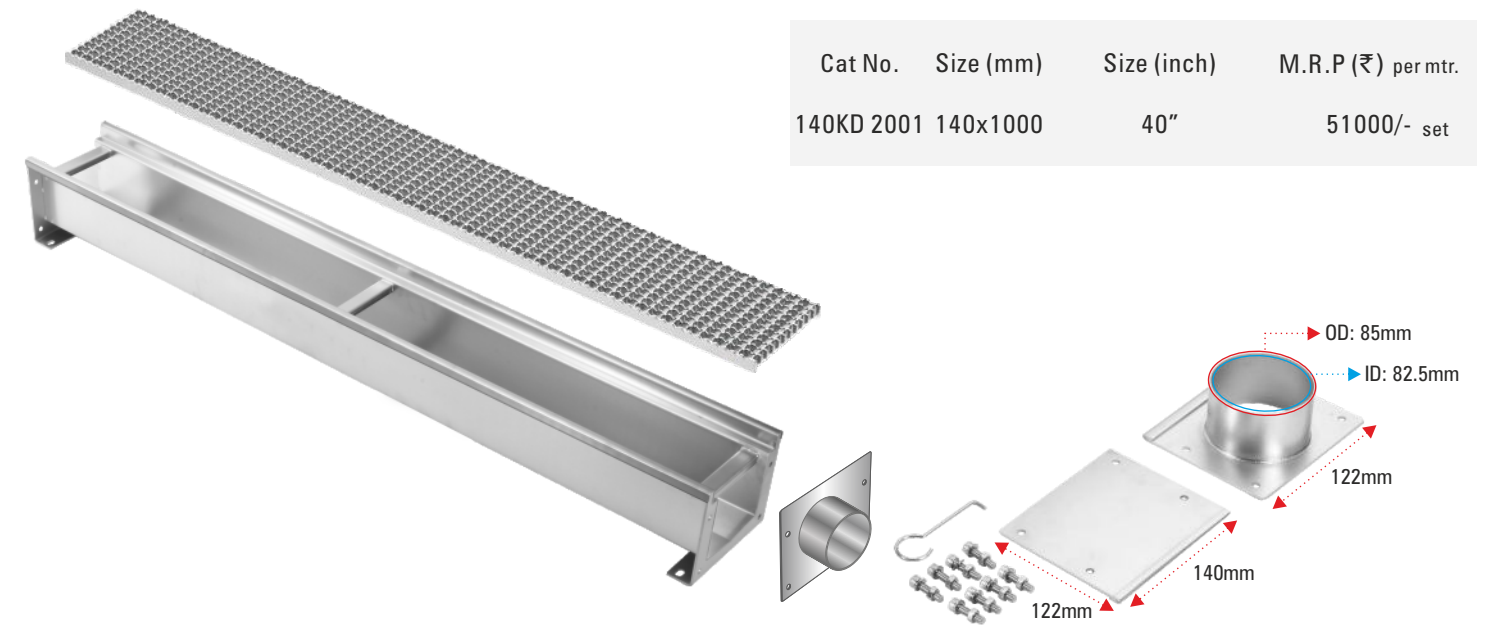

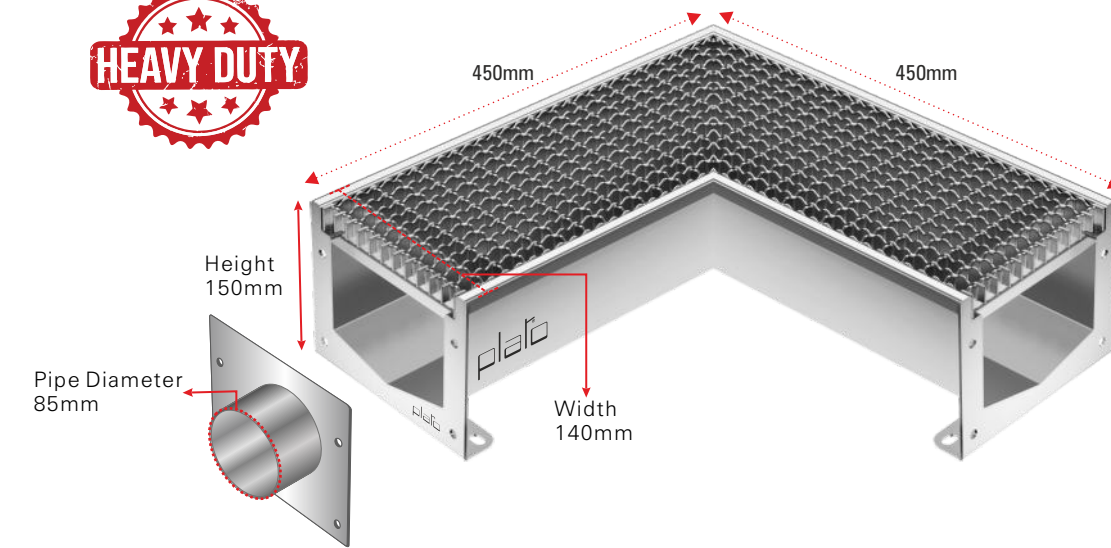

SPECIFICATION

- Installation depth **150 mm**
- Drainage capacity **250 Ltr/min**
- NO LEAK** Anti Leak

APPLICATION

- Restaurant's Kitchen
- Parking
- Swimming Pool
- Hotels / Hospitals
- Supermarket, Mall & etc.

Spl. Heavy Duty Commercial Shower Drainer (**JUMBO**)

Cat No.	Size (mm)	Size (inch)	M.R.P (₹) per mtr.
140KD 2010	450x450	18"x18"	51000/- set

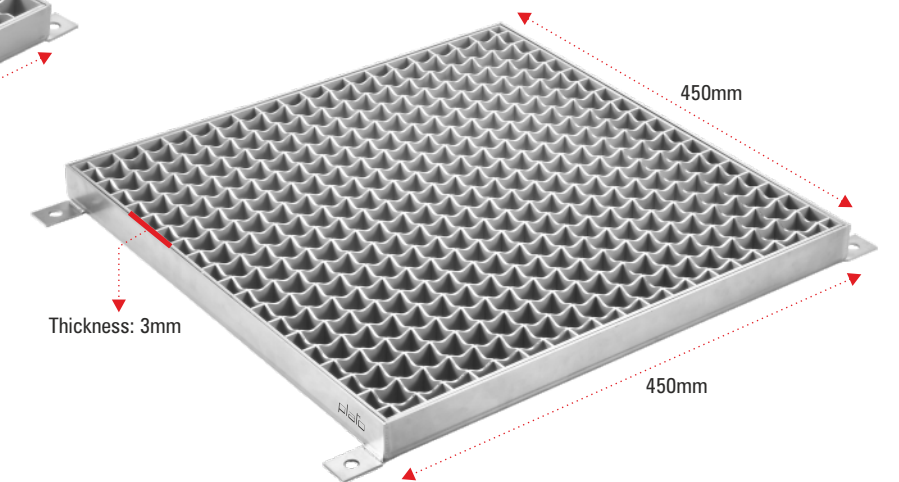
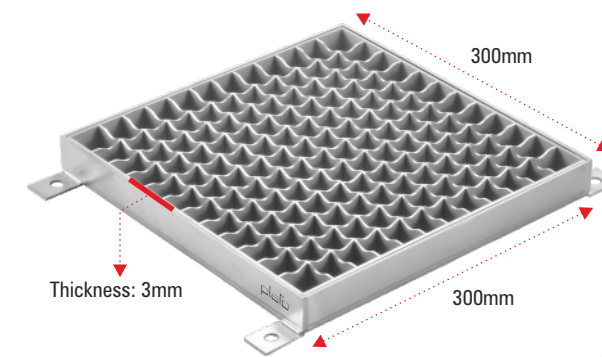
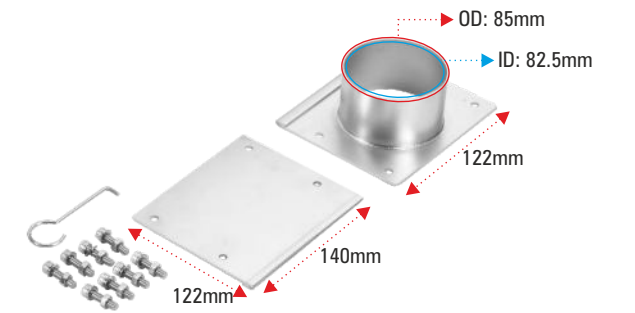

Spl. Heavy Duty Commercial Man Hole Cover (**JUMBO**)

Cat No.	Size (mm)	Size (inch)	M.R.P (₹) per pc.
CDGT 2080	300x300	12"x12"	9000/-
CDGT 2081	450x450	18"x18"	15000/-

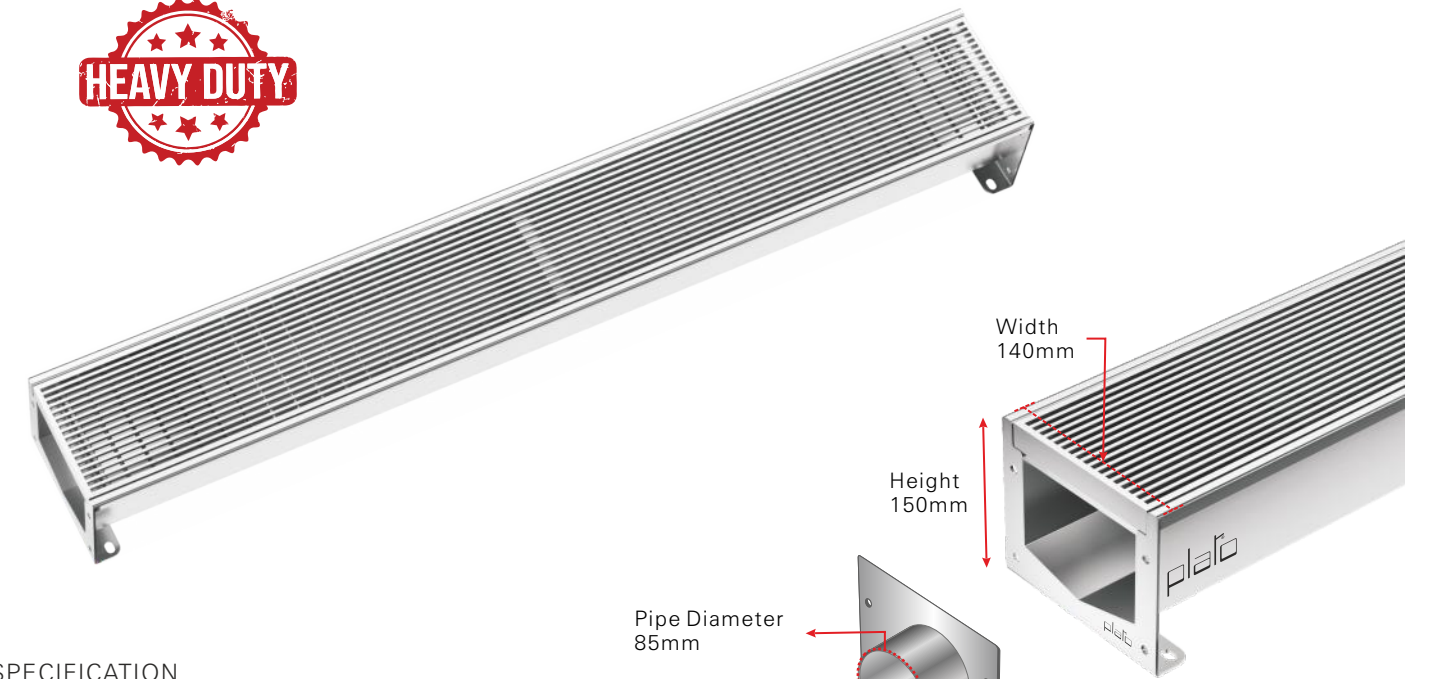
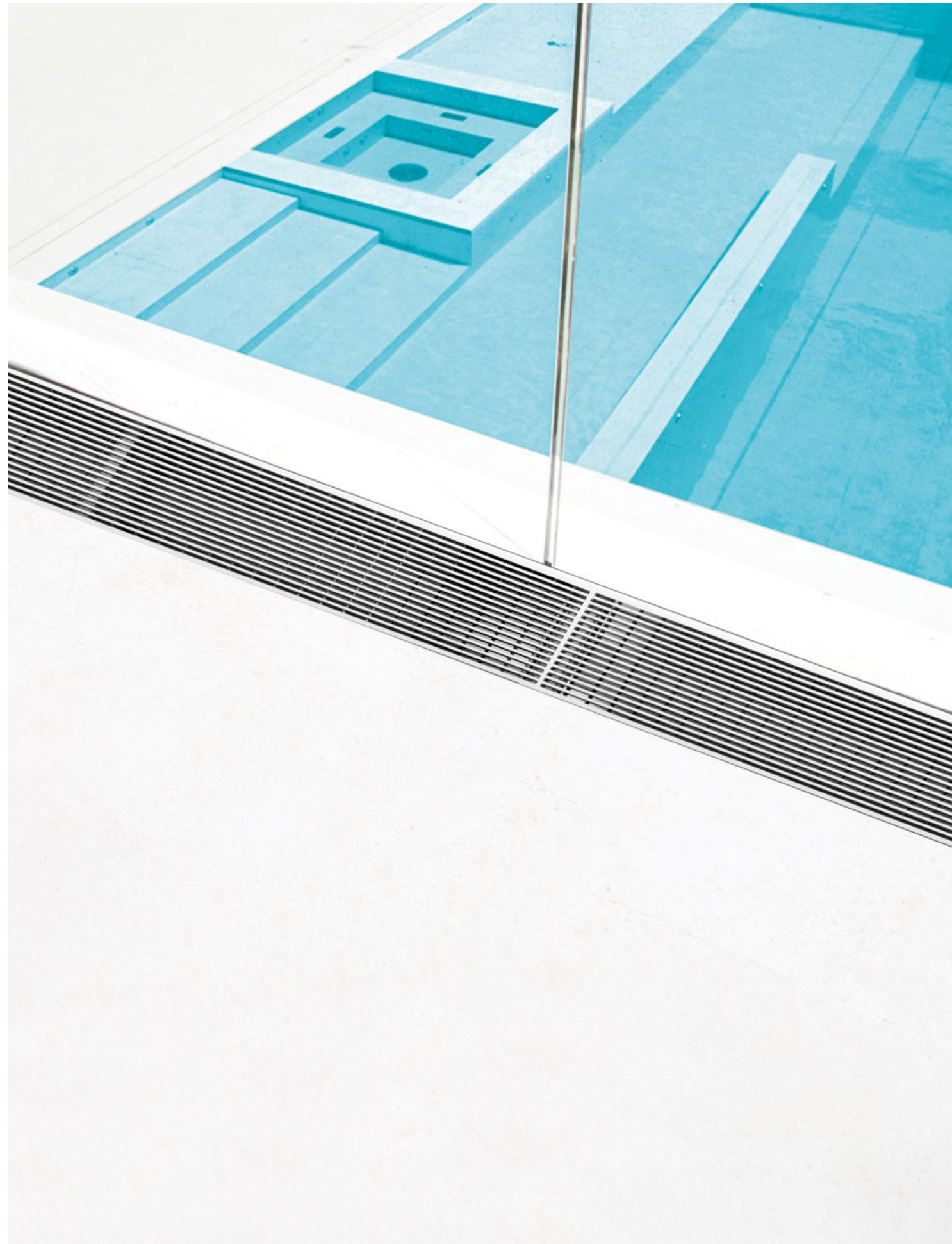

SPECIFICATION



Installation depth
150 mm



Drainage capacity
250 Ltr/min



NO LEAK Anti Leak

Pipe Diameter
85mm

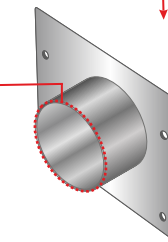

APPLICATION

- Housing Complex
- Parking
- Swimming Pool
- Hotels / Hospitals
- Supermarket, Mall & etc.

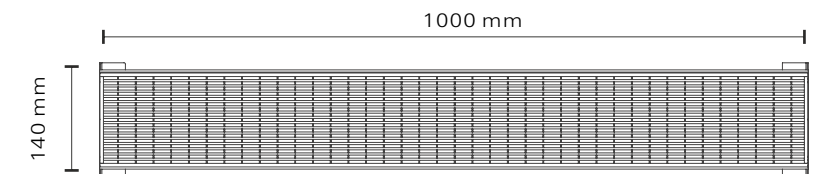

Spl. Heavy Duty Commercial Shower Drainer (**DEXTON**)

Cat No.	Size (mm)	Size (inch)	M.R.P (₹) per mtr.
140LD 2101	140x1000	40"	51000/- set

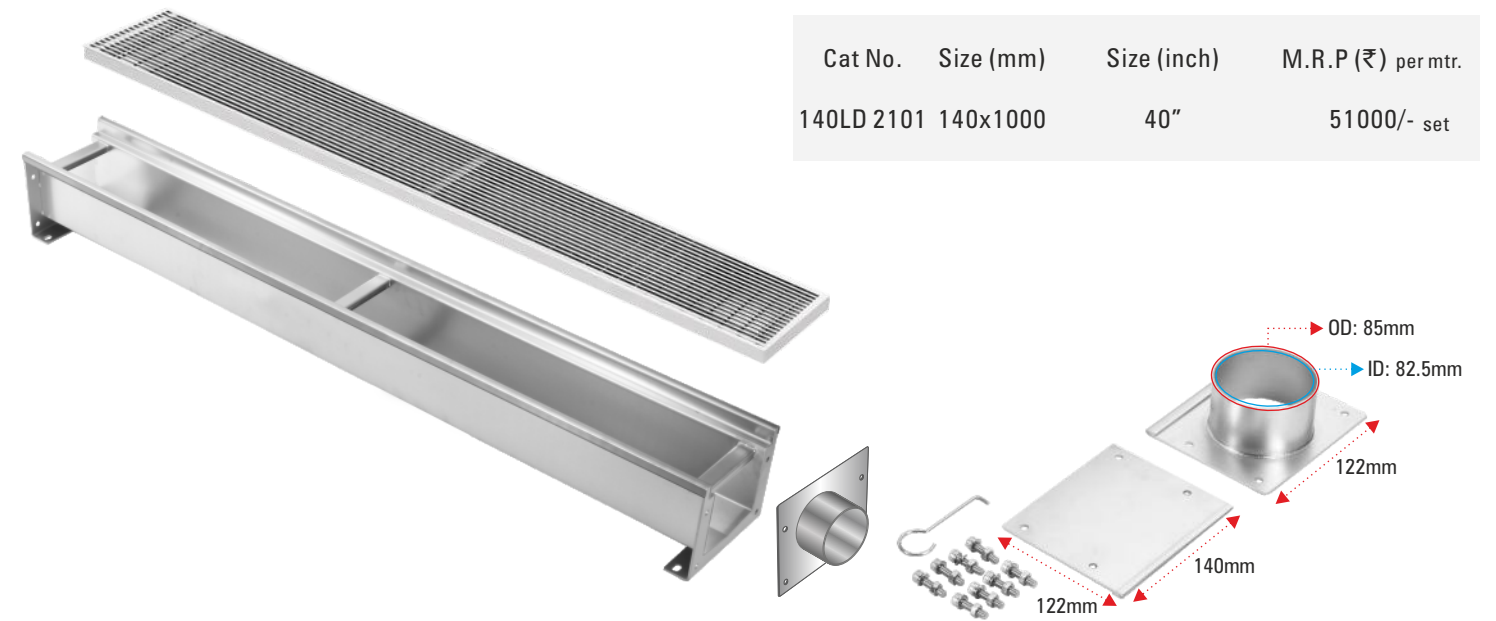

DEXTON DRAINER

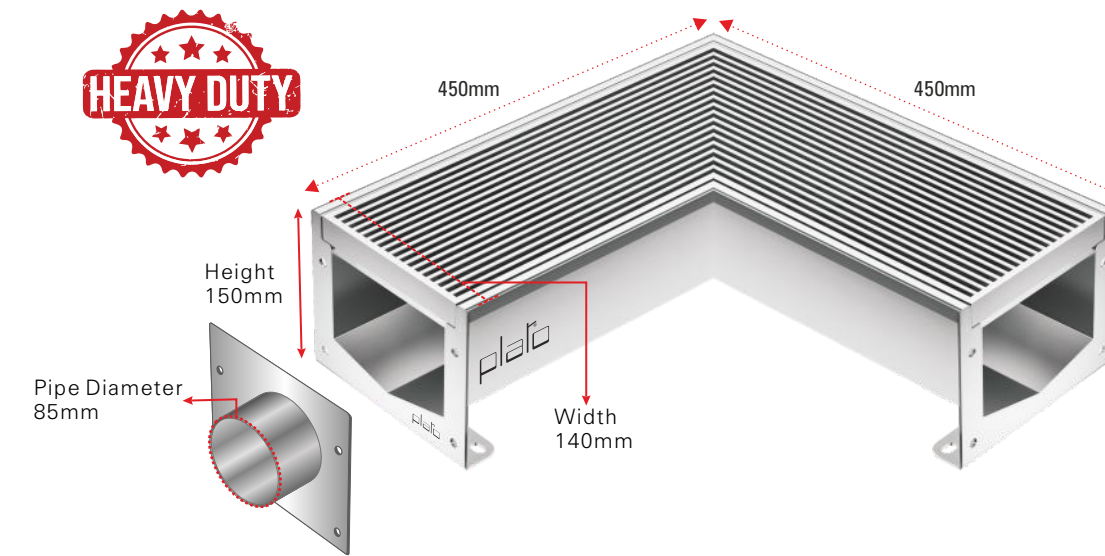

SPECIFICATION

- Installation depth **150 mm**
- Drainage capacity **250 Ltr/min**
- NO LEAK** Anti Leak

APPLICATION

- Restaurant's Kitchen
- Parking
- Swimming Pool
- Hotels / Hospitals
- Supermarket, Mall & etc.

Spl. Heavy Duty Commercial Shower Drainer (**DEXTON**)

Cat No.	Size (mm)	Size (inch)	M.R.P (₹) per mtr.
140LD 2110	450x450	18"x18"	51000/- set

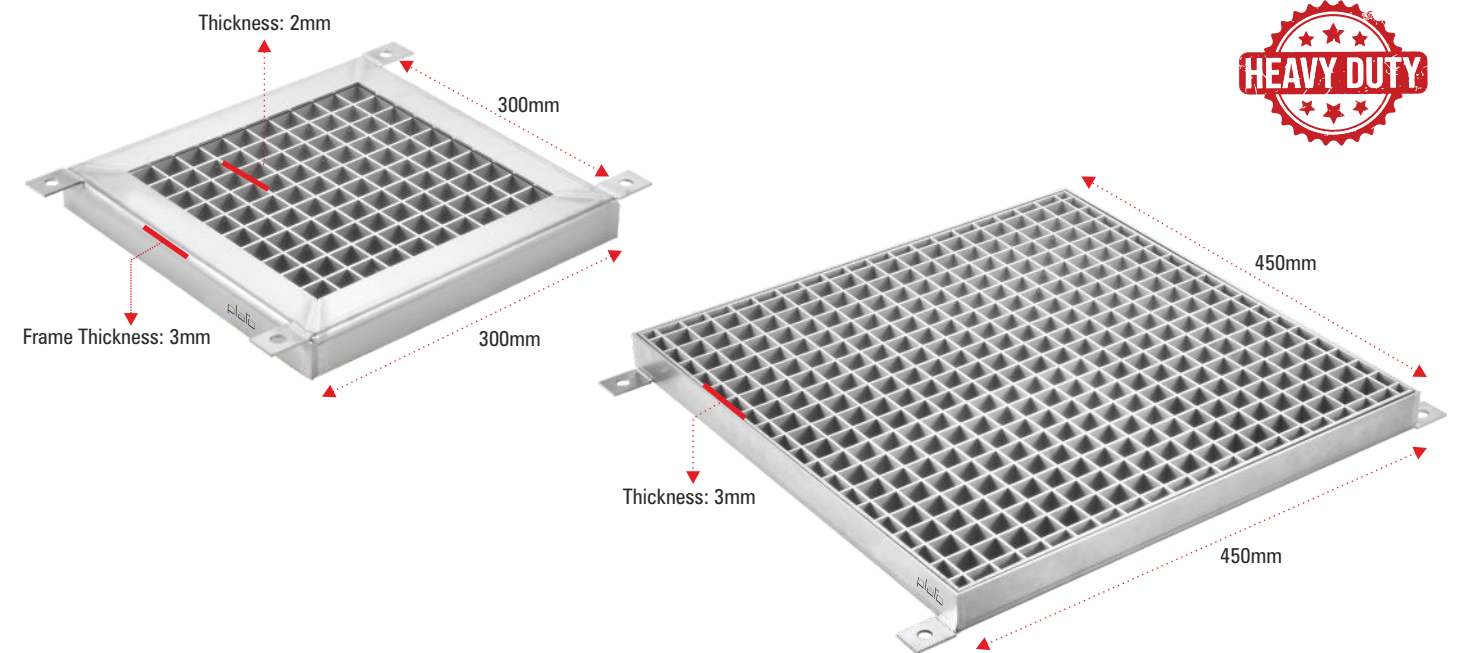
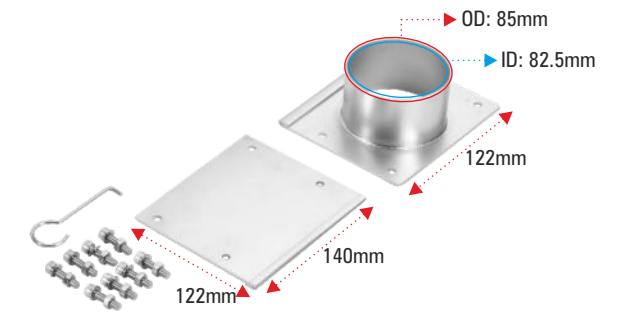

Spl. Heavy Duty Commercial Man Hole Cover (**DEXTON**)

Cat No.	Size (mm)	Size (inch)	M.R.P (₹) per pc.
CDGT 2091	300x300	12"x12"	9000/-
CDGT 2092	450x450	18"x18"	15000/-

LINZO DRAINER



SPECIFICATION

- Installation depth **150 mm**
- Drainage capacity **250 Ltr/min**
- NO LEAK** Anti Leak

APPLICATION

- Restaurant's Kitchen
- Parking
- Swimming Pool
- Hotels / Hospitals
- Supermarket, Mall & etc.

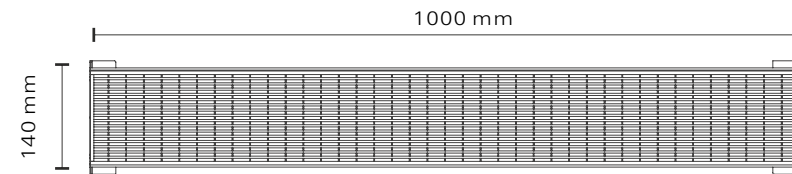

Spl. Heavy Duty Commercial Shower Drainer (LINZO)

Cat No.	Size (mm)	Size (inch)	M.R.P (₹) per mtr.
140CD 2201	140x1000	40"	39000/- set

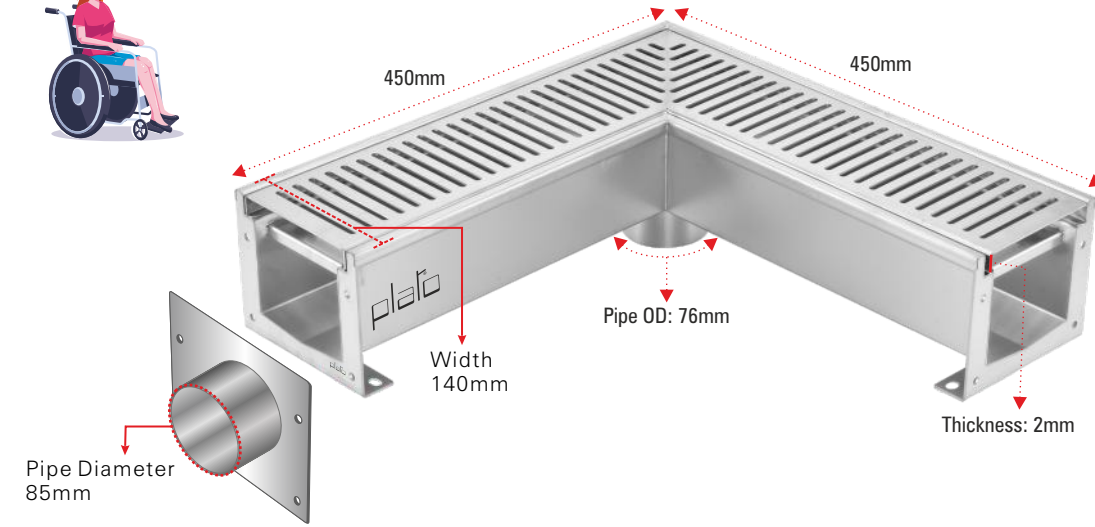
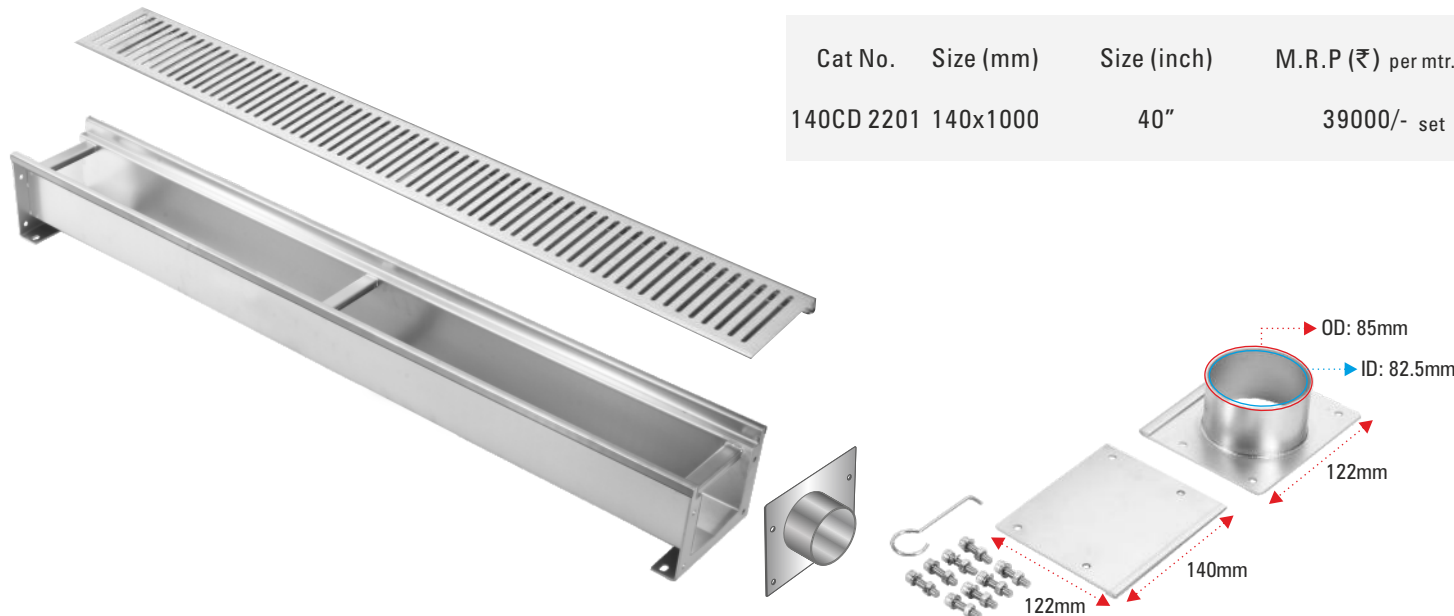

SPECIFICATION

- Installation depth **150 mm**
- Drainage capacity **250 Ltr/min**
- NO LEAK** Anti Leak

APPLICATION

- Restaurant's Kitchen
- Parking
- Swimming Pool
- Hotels / Hospitals
- Supermarket, Mall & etc.

Spl. Heavy Duty Commercial Shower Drainer (LINZO)

Cat No.	Size (mm)	Size (inch)	M.R.P (₹) per mtr.
140LD 2210	450x450	18"x18"	39000/- set

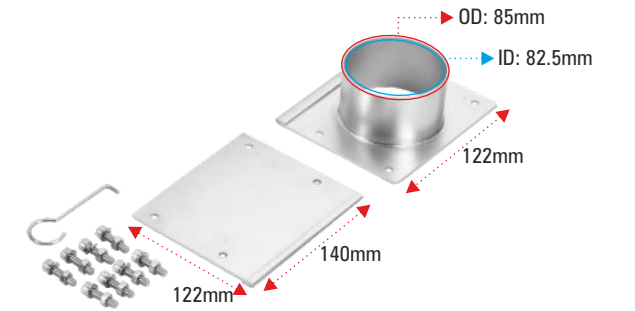

SLOT DRAIN



SPECIFICATION

- Installation depth **as required**
- Drainage capacity **250 Ltr/min**
- NO LEAK** Anti Leak

APPLICATION

- Hotels & Bungalows
- Lawns & Outdoors
- Big Halls & Balconies
- Supermarket, Mall & etc.

Spl. Heavy Duty Slot Drain

Cat No.	Size (mm)	Size (inch)	M.R.P (₹) per mtr.
	140x1000	40"	on demand

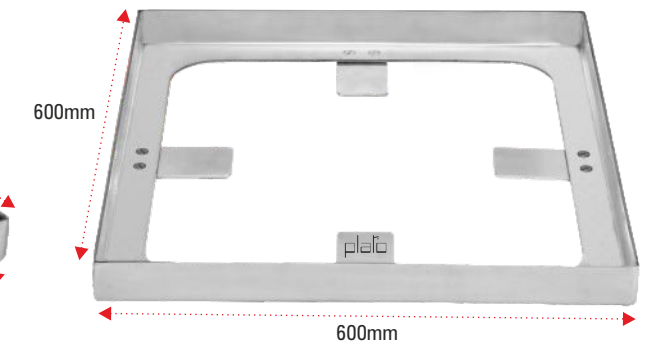
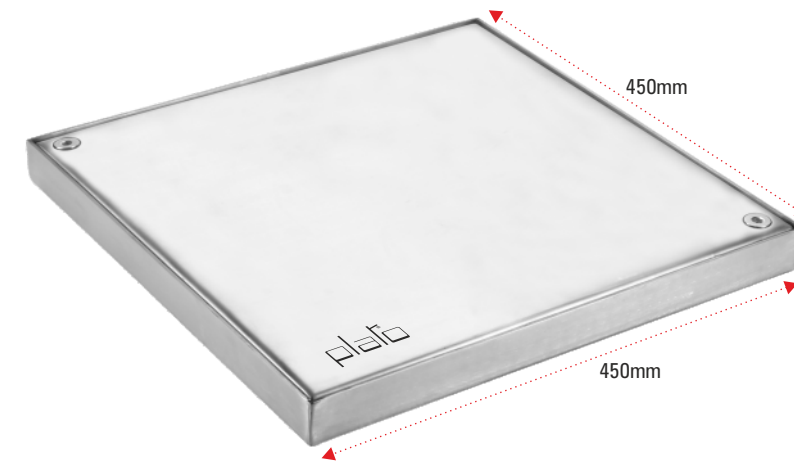
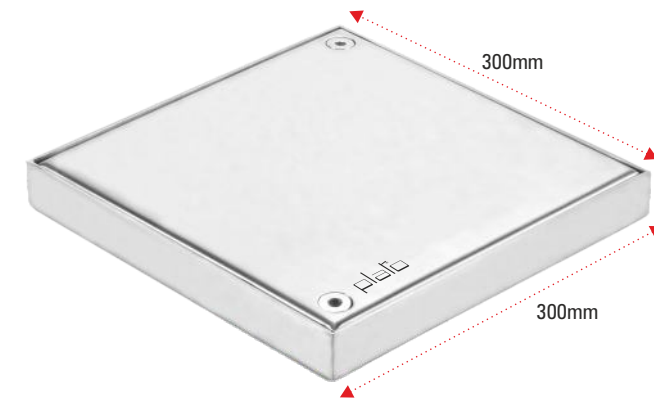
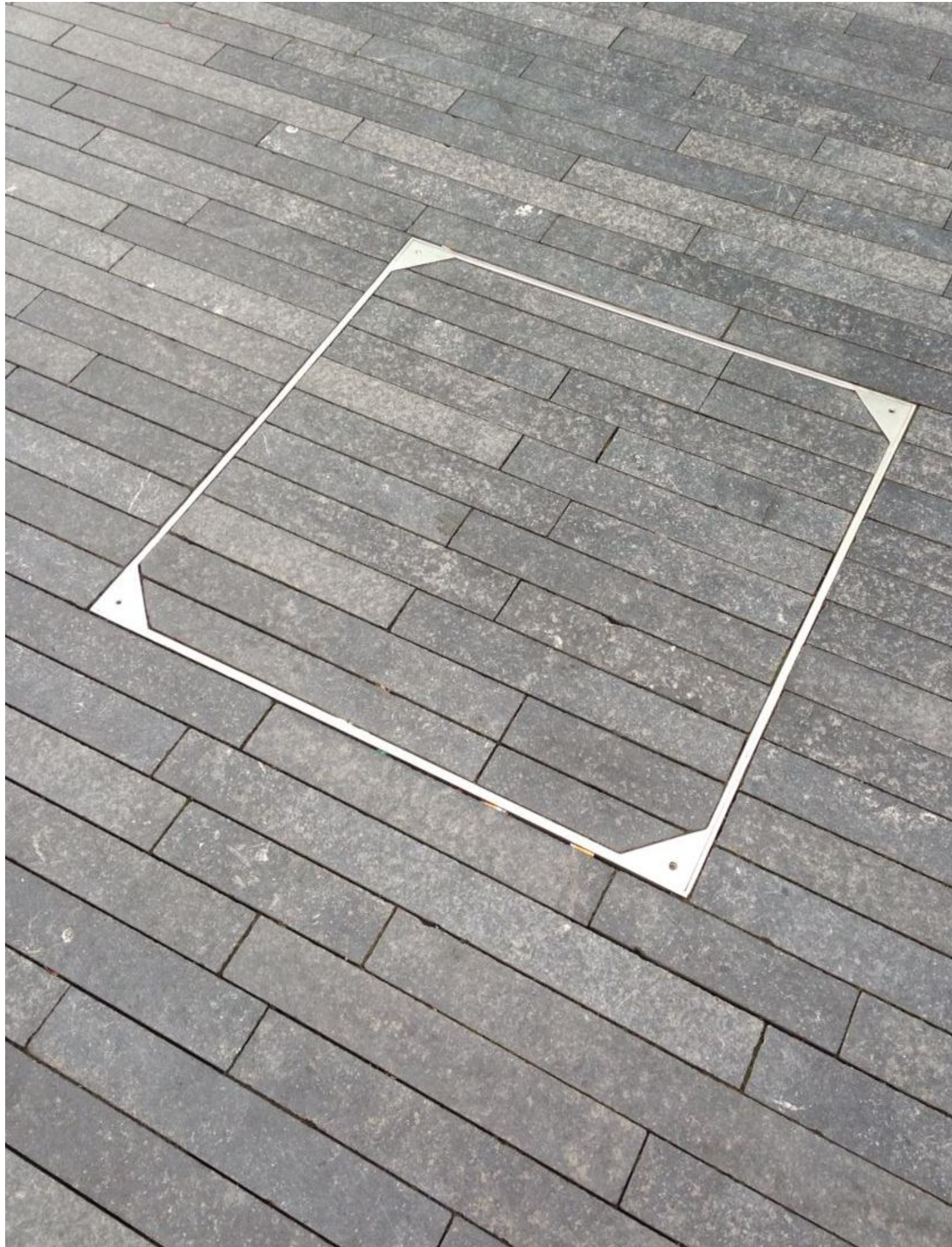

Accessories included*

Spl. GT Cover Heavy Duty Commercial

Cat No.	Size (mm)	Size (inch)	M.R.P (₹) per pc.
TGT 2071	300x300	12"x12"	14400/-
TGT 2072	450x450	18"x18"	24000/-
TGT 2073	600x600	24"x24"	34500/-

GT Cover Heavy Duty Commercial

Cat No.	Size (mm)	Size (inch)	M.R.P (₹) per pc.
LGT 2061	300x300	12"x12"	7200/-
LGT 2062	450x450	18"x18"	12000/-
LGT 2063	600x600	24"x24"	21000/-

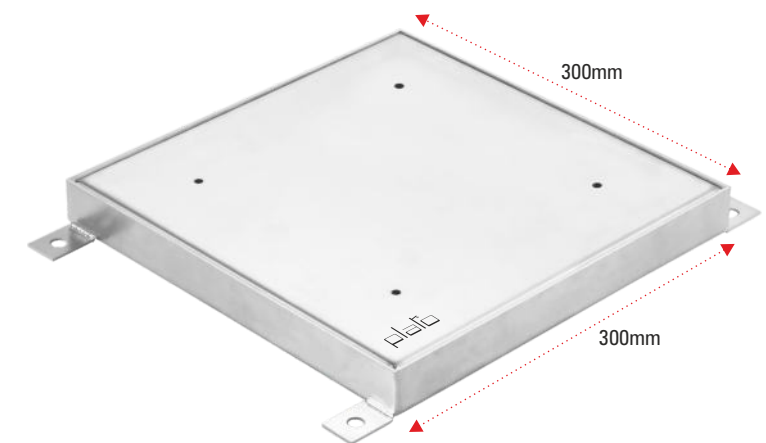

LIQUID SOAP DISPENSER



SS Tissue Paper Dispenser SS304
AISI 1981 - ₹ 5600/-



100%
SS 304
GRADE

Paper Dispenser with Bin SS304
AISI 1986 - ₹ 54000/-



Liquid Soap Dispenser
500ml (SS 304)
AISI 1982 - ₹ 2400/-



Liquid Soap Dispenser
1000ml (SS 304)
AISI 1983 - ₹ 3900/-

GRAB BAR BRASS



C.P Brass Grab Bar Heavy
AISI 1951 - ₹ 2280/- (300mm)
AISI 1952 - ₹ 2640/- (375mm)



C.P Brass Grab Bar Heavy
AISI 1953 - ₹ 3210/- (450mm)
AISI 1954 - ₹ 4410/- (600mm)



C.P Brass Shower Grab Bar Heavy
AISI 1955 - ₹ 3210/- (450mm)
AISI 1956 - ₹ 4410/- (600mm)

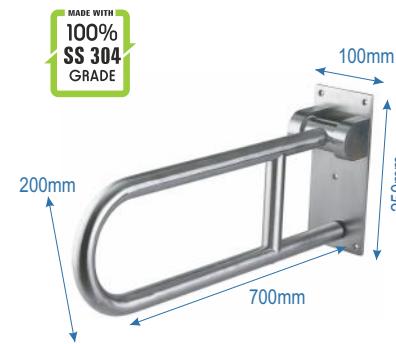

SS 304 Grab Bar for
Differently Able
AISI 1958 - ₹ 8700/-

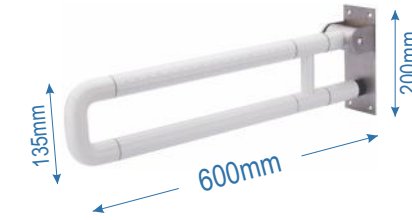

Disabled Grab Bar Swing
Wall Mount (SS)
AISI 1969 - ₹ 7800/-



Disabled Grab Bar U-Shaped
Hand Rail Swing Folding (SS)
AISI 1964 - ₹ 13200/-



Disabled Grab U-Shaped
Hand Rail (SS)
AISI 1961 - ₹ 9000/-



Disabled Grab L-Shaped
Hand Rail (SS)
AISI 1963 - ₹ 6000/-



Disabled Grab Bar L-Shaped
Hand Rail (SS)
AISI 1967 - ₹ 8700/-



Disabled Grab Bar U-Shaped
AISI 1971 - ₹ 9000/-



Disabled Grab Bar L-Shaped
Hand Rail
AISI 1973 - ₹ 6600/-



Disabled Grab Bar
AISI 1968 - ₹ 3600/-



Disabled Grab Bar
AISI 1970 (400mm) - ₹ 1620/-

SHOWER SEAT



- Hospital Reinforced Card
- Hold up 200kg
- Stainless Steel
- Non-Slip Nylon Covered
- Sturdy and Comfortable
- Fold-up to save space



Shower Seat with SS Hinges
AISI 1801 - ₹ 18000/-



Shower Seat with SS Hinges
AISI 1802 - ₹ 19800/-



Wall Mounted Shower Seat with Stand
AISI 1803 - ₹ 12000/-

BABY NURSING STATION



Baby Protection Seat (Wall Mount)
AISI 1901 - ₹ 9000/-

SS GRATINGS & COCKROACH TRAPS



FLOOR GRATINGS & COCKROACH TRAPS



Round Plain Grating
AISI 1003 (100mm) ₹ 144/-
AISI 1004 (125mm) ₹ 172/-



Round Grating with Frame
AISI 1005 (125mm) ₹ 270/-



Round Cockroach Trap
AISI 1006 (125mm) ₹ 690/-



Round Cockroach Trap
AISI 1007 (125mm) ₹ 690/-



Square Grating with Frame
AISI 1008 (125x125mm) ₹ 420/-
AISI 1009 (150x150mm) ₹ 540/-



Square Cockroach Trap
AISI 1010 (125x125mm) ₹ 750/-
AISI 1011 (150x150mm) ₹ 900/-



Square Cockroach Trap
AISI 1012 (125x125mm) ₹ 750/-
AISI 1013 (150x150mm) ₹ 900/-



Heavy Cockroach Trap
AISI 1014 (125x125mm) ₹ 840/-



Heavy Cockroach Trap
AISI 1015 (125x125mm) ₹ 840/-



Heavy Cockroach Trap
AISI 1016 (125x125mm) ₹ 840/-



Square Spl. Grating
AISI 1017 (100x100mm) ₹ 300/-
AISI 1018 (125x125mm) ₹ 450/-
AISI 1019 (150x150mm) ₹ 480/-
AISI 1020 (200x200mm) ₹ 600/-



Heavy Cockroach Trap - Gold
AISI 1015 (125x125mm) ₹ 1680/-





Heavy Cockroach Trap - Rose Gold
AISI 1015 (125x125mm) ₹ 1680/-







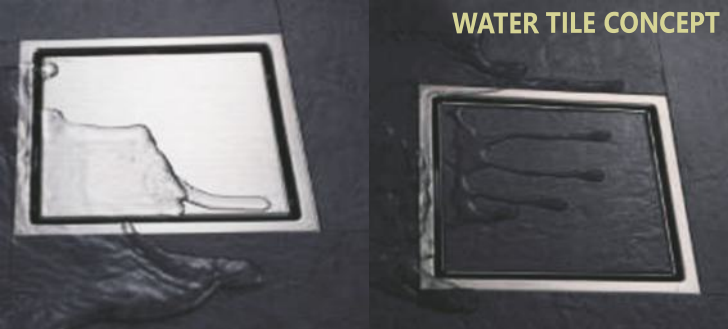





Heavy Cockroach Trap - Black
AISI 1015 (125x125mm) ₹ 1680/-

POP-UP TRAP & TILE GRATINGS

 <p>SS 304 Foot Operated Pop-up AISI 1021 (150x150mm) ₹ 1500/-</p>	 <p>Tile Grating Heavy AISI 1022 (125x125mm) ₹ 1350/- AISI 1023 (150x150mm) ₹ 1500/-</p>	 <p>WATER TILE CONCEPT</p>
---	---	---

HEAVY DESIGNER GRATINGS

 <p>Line Heavy Designer Grating AISI 1060 (6"x6") ₹ 720/- AISI 1070 (5"x5") ₹ 600/-</p>	 <p>Plain Heavy Designer Grating AISI 1061 (6"x6") ₹ 720/- AISI 1071 (5"x5") ₹ 600/-</p>	 <p>• Odour free Coupler</p> 	
 <p>Boxes Heavy Designer Grating AISI 1062 (6"x6") ₹ 720/- AISI 1072 (5"x5") ₹ 600/-</p>	 <p>Wave Heavy Designer Grating AISI 1063 (6"x6") ₹ 720/- AISI 1073 (5"x5") ₹ 600/-</p>		
 <p>Wow Heavy Designer Grating AISI 1064 (6"x6") ₹ 720/- AISI 1074 (5"x5") ₹ 600/-</p>	 <p>Croc Heavy Designer Grating AISI 1065 (6"x6") ₹ 720/- AISI 1075 (5"x5") ₹ 600/-</p>		
 <p>New Boxe Heavy Designer Grating AISI 1066 (6"x6") ₹ 720/- AISI 1076 (5"x5") ₹ 600/-</p>	 <p>Line Heavy Designer Grating AISI 1060 GD (6"x6") ₹ 1620/- AISI 1070 GD (5"x5") ₹ 1200/-</p>		

HDPE CHANNEL DRAIN

INTRODUCING



Channel Drain

Cat No.	Size (mm)	Size (inch)	M.R.P (₹)



Spl. Drainer with Outlet Attachent

Cat No.	Size (mm)	Size (inch)	M.R.P (₹)



Spl. Drain with Outlet Attachent

Cat No.	Size (mm)	Size (inch)	M.R.P (₹)